



**FREE
DELIVERY**
on all orders
over £250
(UK Mainland*)

★ Trustpilot **★★★★★**
Rated Excellent by our customers

Buy Online
Today Or
Request A Free
Quotation

**As Low As
£915**
Page 23 **Kimmeridge
Cycle Shelter**



**As Low As
£320**
Page 37 **Standard Picnic Table**



**As Low As
£2,550**
Page 19 **Freestanding Shelter**



**As Low As
£90**
Page 28 **Sheffield Toast Racks**



**As Low As
£375**
Page 35 **Maxi 140 Envirobin**



**As Low As
£250**
Page 44 **Captain's Treble Seat**



**As Low As
£1,995**
Page 34

NBB Outdoors

Outdoor Product Solutions For Every Build

If you require shelters manufactured from top quality materials and with **market-leading guarantees**, look no further than NBB Outdoors. You can purchase on a supply-only basis or take advantage of a **full 'turn-key' supply and installation service** in adherence with all site rules, and relevant on-site certification.

With nationwide restrictions now removed, businesses and educational establishments the nation over are adjusting to optimise their outdoor areas whilst **research continues to validate that meeting outdoors reduces the risk of transmission**. Our **comprehensive range of outdoor product solutions** can help you to utilise your unused space and unlock your premises' 'hidden' potential.

Inside our latest catalogue you will find our most popular ranges available, with something **for every application and budget**. See our modular Domed and Apex roof shelters on pages 12, 13, 32 and 33. Available in a range of configurations these NEW additions to the range can be **delivered to your location within two weeks of order!** You will also find our classic Sheffield Toast Racks on page 28. Available at **market-leading prices** they are a fantastic cost-effective cycle storage solution.

Can't find what you're looking for? Our expert team can help. From design to installation, we are on hand with advice on styles, configurations and finishes to ensure your shelter/furniture is perfectly tailored to your exact requirements.

What's more, we offer initial **quotations on custom projects absolutely free of charge with no obligation attached**. Contact us today; email sales@nobutts.co.uk or call **freephone 0800 1777 052**.

P.S. Don't forget, we offer **free delivery on all orders** over £250 with a UK mainland address* and **30-day instant credit** to established businesses and educational establishments

INSTALLATION & GROUNDWORKS AVAILABLE

FREE DELIVERY
On all orders over £250 (UK Mainland)*

INSTANT £500 CREDIT ACCOUNTS
• Simple invoicing
• Available to established businesses & schools

FREE HELP & ADVICE, QUOTATIONS & INSTALLATION
Call 0800 1777 052

OUR ACCREDITATIONS
NBB are proud members of Constructionline, CHAS and the Construction Skills Certification Scheme. We are also an ISO 9001 accredited company and manufacture our range to ISO and BS EN standards

IT'S SO EASY TO ORDER

Order By Phone

Call our experts for FREE advice and to place an order...

0800 1777 052

Order Online

If you know what you need then simply go online to place your order...

NoButts.co.uk

Order By Email

Sales@NoButts.co.uk

Many more products online!



- ✓ 100's Of Shelters Online
- ✓ Custom Designs Available
- ✓ Extensive Outdoor Facilities Product Range
- ✓ Testimonials & Case Studies
- ✓ Technical Support
- ✓ Free Downloads
- ✓ Market Leading Guarantees



Proud member of Made in Britain

Made in Britain are a growing British manufacturing community, united with the use of the registered collective mark. This mark can only be used by members of Made in Britain, who have to meet strict criteria to guarantee the products on offer are manufactured to the very highest standard here in Britain.



WE ARE HERE TO HELP...



FREE No Obligation Quotation

If you require installation for any of our shelters, or if you require something a little different, simply email our sales team today.

They will discuss your requirements and answer any questions. You will be provided with a free, no obligation quotation, usually within a couple of days of receiving your information.

WHY CHOOSE NBB OUTDOORS



Huge Range

We offer hundreds of shelter products to suit any need, location or budget



FREE Delivery

On all orders over £250 (UK Mainland)*



Installation Service

Our shelters can be installed by our team of experts at a time which is convenient for you



Bespoke Shelters

Here at NBB, we can design, manufacture and install bespoke shelters tailored to you



UK Manufactured

With 27 years' experience we manufacture our products in the UK



Quality & Price Promise
If you're not 100% satisfied with your purchase, return to us in a saleable condition, within 30 days for a full no quibble refund (T&C's apply).



Website: NoButts.co.uk

INSIDE NBB OUTDOORS



P.6



P.14



P.15



P.19



P.23



P.28



P.32



P.34



P.37



P.44



P.50

Bespoke Shelters	Pages 4-5
Smoking Shelters	Pages 6-14
Cigarette Bins & Signs	Pages 15-17
Walkway Shelters	Pages 18-21
Canopies	Page 22
Cycle Shelters	Pages 23-25
Cycle Compounds	Pages 26-27
Cycle Racks & Stands	Page 28
Case Studies	Pages 29-30
Waiting Shelters	Pages 31-33
Bins & Wheelie Bin Stores	Pages 34-35
Recycled Plastic Furniture	Pages 36-47
Entrance & Exterior Matting	Pages 48-49
NEW Parasols & Patio Heaters	Page 50

Maintenance
The material for all of our products is covered by 'no maintenance required' warranties varying between 5, 10 and 15 years.



Market Leading Guarantees
Following the manufacturers guidelines, these products should give you 25 years of service.

* Please note free carriage to UK mainland only. Some locations may incur an additional supplement. Prices in this catalogue exclude VAT. All prices correct at time of print.

Quality Bespoke Shelters

Helping to turn your idea into a reality...

> Idea

> Design

> Solution

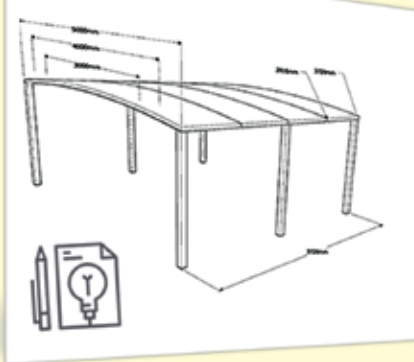

Request A Free Quotation

1. Take A Photo



Simply take a photo of the area you would like to put a shelter. Try to provide a few shots from different angles - the more we know about the area, the more detailed we can be!

2. Send A Photo



Send your photos, area measurements and requirements to Sales@NoButts.co.uk. We'll take a look at this and get in touch if we need more information from you.

3. Free Quotation



We will raise a free no obligation quotation usually within a couple of days after receiving your information. Inside your quotation pack you will find useful information such as case studies, and links to free downloadable guides.

Our Process



Enquiry - Step 1

Request a free no obligation quotation. Simply email Sales@NoButts.co.uk with your requirements and we'll be in touch if we need more information. If you require installation, it helps if you can send an image and area measurements of where it will be situated. Alternatively, call our friendly team on freephone 0800 1777 052.



Design - Step 4

We will visit your site and our expert design team will finalise the specifications of your shelter, and add it to the production schedule. Don't forget if you need technical specifications or general arrangement drawings, we can supply these too.



Quotation - Step 2

We will raise your free no obligation quotation based on your requirements, usually within a couple of working days after receiving the request. Within your quotation pack will also be useful information such as case studies, links to free downloadable guides and your quotation!



Manufacture - Step 5

All of our bespoke shelters are manufactured in the UK and we're proud to be an ISO 9001 accredited company. We use the latest technology, and our team of qualified engineers check each structure for stability and durability.



Order - Step 3

We will contact you shortly after sending out your quotation pack to ensure you are happy and field any questions you might have. If you'd like to proceed, you can place your order:

- By Freephone - 0800 1777 052
- By Email - Sales@NoButts.co.uk
- By Freepost - NBB LTD



Installation - Step 6

When your shelter is manufactured, we will contact you to confirm a convenient installation date. We work closely with you to ensure minimum disruption to your normal working day and keep your staff, visitors and pupils safe.



One of our bespoke shelter installations at St Stephen's Infant School, a Freestanding Winterbourne Walkway Shelter to offer an extended learning environment outside of the classroom.

The finished project takes the form of a 22m x 3.48m steel tube shelter with guttering, galvanised and powder coated to complement the school colours. This surface treatment means the structure will be guaranteed to last 25 years, serving the school for many years to come.

Can't find what you're looking for? Our bespoke shelter service will allow you to utilise your unused space and unleash your premises' 'hidden' potential!

**Need a site survey or quote?
Call us on 0800 1777 052**



Model Shown: HRN04



Model Shown: CSG10



HORTON SMOKING SHELTER WITH INTEGRATED SEATING

Freestanding smoking shelter with integrated perch seating

FEATURES & BENEFITS

- Strong freestanding design creates a dedicated smoking shelter with perch style seating
- Versatile structure available in two configurations, either four-sided (as shown) or open fronted (without front panel)
- Compliant with Smoking Ban Legislation - Parliament Act 3368

INSTALLATION

Our shelters, walkways and canopies are easy to install and come supplied with full assembly instructions. Alternatively, we have a team of experienced installers who can carry out the work for you. Contact our friendly sales team for a price on 0800 1777 052

SPECIFICATIONS

- Mild steel frame, zinc coated and supplied powder coated in your choice of standard RAL colour
- Robust clear 16mm cellular polycarbonate roofing
- Clear polycarbonate glazing is UV stabilised, it will not turn yellow or brittle in sunlight

OPTIONAL EXTRAS

- Cigarette bins available either freestanding and/or wall attached (see pages 15-17)
- Clearly indicate your shelter's purpose with designated smoking area signs (see page 17)

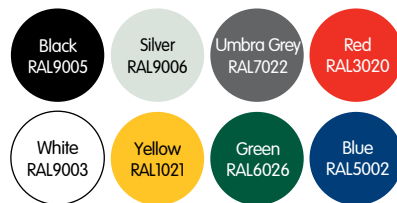

4-Sided

Code	Capacity	H x L x W (mm)	Price Each
HRN01	3-5 People	2110 x 2100 x 1074	£1,150
HRN02	5-7 People	2110 x 3146 x 1074	£1,400
HRN03	6-8 People	2110 x 4182 x 1074	£1,745
HRN04	6-8 People	2110 x 2110 x 2100	£1,650
HRN05	10-12 People	2110 x 3146 x 2113	£1,895
HRN06	12-14 People	2110 x 4182 x 2113	£2,375
HRN07	14-16 People	2110 x 5218 x 2113	£2,745



Model Shown: Integrated Seat (supplied as standard)

Configuration Drawings



Visit NoButts.co.uk for all configurations

Open Fronted

Code	Capacity	H x L x W (mm)	Price Each
HRN08	3-5 People	2110 x 2110 x 1074	£1,045
HRN09	5-7 People	2110 x 3146 x 1074	£1,225
HRN10	6-8 People	2110 x 4182 x 1074	£1,550
HRN11	6-8 People	2110 x 2110 x 2100	£1,450
HRN12	10-12 People	2110 x 3146 x 2113	£1,700
HRN13	12-14 People	2110 x 4182 x 2113	£2,175

BUDGET OPEN FRONTED SMOKING SHELTER

Entry level open fronted smoking shelter

FEATURES & BENEFITS

- Popular design open fronted freestanding smoking shelter
- Creates a practical and functional designated smoking area for any premises
- Strong, clear polycarbonate roofing/glazing for light and airy feel
- Compliant with Smoking Ban Legislation - Parliament Act 3368

SPECIFICATIONS:

- Mild steel frame, zinc coated and supplied powder coated in your choice of standard RAL colour
- Robust clear 16mm cellular polycarbonate roofing
- Clear polycarbonate glazing is UV stabilised, it will not turn yellow or brittle in sunlight

OPTIONAL EXTRAS

- Cigarette bins available either freestanding and/or wall attached (see pages 15-17)
- Clearly indicate your shelter's purpose with designated smoking area signs (see page 17)

- Non-standard RAL colours to match your business colours and/ or existing surroundings
- Add perch seats for additional comfort, available in a choice of four standard RAL colours (see page 12)
- Shelters are supplied surface mountable as standard, optional extended feet can be purchased for sub-surfacing

INSTALLATION

Our shelters, walkways and canopies are easy to install and come supplied with full assembly instructions. Alternatively, we have a team of experienced installers who can carry out the work for you. Contact our friendly sales team for a price on 0800 1777 052

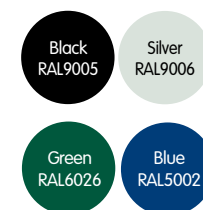

Configuration Drawings



Visit NoButts.co.uk for all configurations

Code	Capacity	H x L x W (mm)	Price Each
CSG07	3-5 People	2110 x 2110 x 1074	£995
CSG08	5-7 People	2110 x 3146 x 1074	£1,175
CSG09	6-8 People	2110 x 4182 x 1074	£1,500
CSG10	6-8 People	2100 x 2100 x 2110	£1,400
CSG11	10-12 People	2110 x 3146 x 2110	£1,650
CSG12	12-14 People	2110 x 4182 x 2110	£2,125





Model Shown: OFFBUND2



SMOKING AREA BUNDLE KIT

Ready-made Smoking Area Kit includes everything you need to create a safe, compliant smoking area

FEATURES & BENEFITS

- Strong freestanding shelter creates a designated smoking area for your premises
- Includes a designated smoking area sign which clearly indicates the shelter's purpose
- Freestanding cigarette bin provided keeps area free from smoking litter
- Front glazing to the shelter keeps smokers further protected from adverse weather
- Compliant with Smoking Ban Legislation - Parliament Act 3368

OPTIONAL EXTRAS

- Non-standard RAL colours to match your business colours and/or existing surroundings
- Add perch seats for additional comfort, available in a choice of four standard RAL colours (see page 12). Alternatively, request a price for non-standard colour to match your shelter
- Shelters are supplied surface mountable as standard, optional extended feet can be purchased for sub-surfacing

INSTALLATION

Our shelters, walkways and canopies are easy to install and come supplied with full assembly instructions. Alternatively, we have a team of experienced installers who can carry out the work for you. Contact our friendly sales team for a price on 0800 1777 052

SPECIFICATIONS

- Mild steel frame, zinc coated and supplied powder coated in your choice of standard RAL colour
- Robust clear 16mm cellular polycarbonate roofing
- Clear polycarbonate glazing is UV stabilised, it will not turn yellow or brittle in sunlight
- Sign - Manufactured from self-adhesive vinyl, conforms to EN 7010:2012
- Hooded top cigarette bin - 1mm Zintec zinc plated mild steel with epoxy/polyester coating in Antique Silver (see page 16 for further details)

FOR CONFIGURATION DRAWINGS SEE PAGE 11



Special Offer

4-Sided Smoking Shelter + Hooded Top Tower Bin + Designated Smoking Area Sign



Save up to **£91.40**



Code	Capacity	H x L x W (mm)	Price Each
OFFBUND1	5-7 People	2110 x 3146 x 1074	£1,395
OFFBUND2	3-5 People	2110 x 2110 x 1074	£1,240
OFFBUND3	6-8 People	2110 x 4182 x 1074	£1,590
OFFBUND4	6-8 People	2110 x 2110 x 2110	£1,690
OFFBUND5	10-12 People	2110 x 3146 x 2110	£1,890
OFFBUND6	12-14 People	2110 x 4182 x 2110	£2,145
OFFBUND7	16-18 People	2110 x 5218 x 2110	£2,595



BEST SELLER



Model Shown: Custom

WINTERBOURNE SMOKING SHELTER

Perfect for providing a designated social/smoking area

FEATURES & BENEFITS

- Robust freestanding shelter which can easily create a designated smoking, vaping or break area
- Compliant with Smoking Ban Legislation - Parliament Act 3368
- Provides cover for outside workspace/machinery, additional protection for walkways or storage for items such as buggies

SPECIFICATIONS

- Steel structure, hot dipped galvanised to ISO 1461 2009 and powder coated in your choice of standard RAL colour
- Robust 16mm triple wall polycarbonate roofing as standard
- 4mm polycarbonate sides face-fixed to structure. Shelter is at least 50% open and therefore compliant with Smoking Ban regulations
- Guttering and downpipes supplied as standard

OPTIONAL EXTRAS

- Opal and coloured roofing
- Non-standard RAL colours to match your business colours
- 100% recycled plastic seating – see pages 36-46

CUSTOM OPTIONS

Available in a choice of standard sizes. Alternatively, call for a price on a custom size option. Due to our modular design system, we have the ability to customise any shelter, walkway or canopy. Please contact our friendly sales team for a free quotation

INSTALLATION

Our shelters, walkways and canopies are easy to install and come supplied with full assembly instructions. Alternatively, we have a team of experienced installers who can carry out the work for you. Contact our friendly sales team for a price on 0800 1777 052

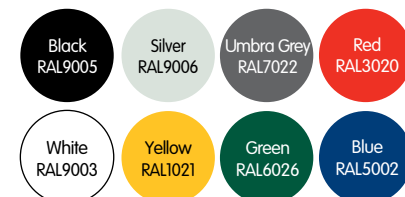

RECYCLED PLASTIC PICNIC TABLES

See page 37 for more details



Code	H x L x W (mm)	Price Each
SCWSF033	2600 x 3000 x 3000	£6,450
SCWSF043	2600 x 3000 x 4000	£6,550
SCWSF034	2600 x 4000 x 3000	£6,750
SCWSF044	2600 x 4000 x 4000	£7,050
SCWSF035	2600 x 5000 x 3000	£7,550
SCWSF045	2600 x 5000 x 4000	£8,100





Model Shown: CDS3ZC (Custom Colour)



Model Shown: CST01

HOLTON SMOKING SHELTER

Stylish, curved shelter protects users from the elements

FEATURES & BENEFITS

- Modern design freestanding open fronted smoking shelter
- Creates a designated smoking area for your premises
- Compliant with Smoking Ban Legislation - Parliament Act 3368

- Clearly indicate your shelter's purpose with designated smoking area signs (see page 17)
- Add perch seats for additional comfort, available in a choice of four standard RAL colours (see page 12)

INSTALLATION

Our shelters, walkways and canopies are easy to install and come supplied with full assembly instructions. Alternatively, we have a team of experienced installers who can carry out the work for you. Contact our friendly sales team for a price on 0800 1777 052

SPECIFICATIONS

- Mild steel frame, zinc coated and supplied powder coated in your choice of standard RAL colour
- 4mm cellular polycarbonate roofing
- Clear polycarbonate glazing is UV stabilised, it will not turn yellow or brittle in sunlight

OPTIONAL EXTRAS

- Cigarette bins available either freestanding or wall attached (see pages 15-17)



Model Shown: CDS4ZC

NEED CIGARETTE BINS?

See pages 15-17 for more details

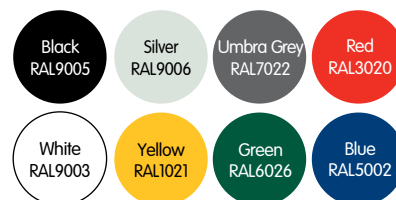

Code	Capacity	H x W x D (mm)	Price Each
CDS2ZC	5 People	2419 x 2000 x 1969	£1,495
CDS3ZC	8 People	2419 x 3000 x 1969	£1,995
CDS4ZC	10 People	2419 x 4000 x 1969	£2,675
CDS5ZC	13 People	2419 x 5000 x 1969	£3,140
CSEND	-	End Panel	£199

BUDGET 4-SIDED SMOKING SHELTER

Low cost solution with added protection from adverse weather

FEATURES & BENEFITS

- Freestanding 4-sided smoking shelter in a conventional design
- Creates a practical and functional designated smoking area for any premises
- Compliant with Smoking Ban Legislation-Parliament Act 3368

SPECIFICATIONS:

- Mild steel frame, zinc coated and supplied powder coated in your choice of standard RAL colour
- Robust clear 16mm cellular polycarbonate roofing
- Clear polycarbonate glazing is UV stabilised, it will not turn yellow or brittle in sunlight

OPTIONAL EXTRAS:

- Non-standard RAL colour to match your business colours and/or existing surroundings

Code	Capacity	H x L x W (mm)	Price Each
CST01	3-5 People	2110 x 2100 x 1074	£1,100
CST02	5-7 People	2110 x 3146 x 1074	£1,350
CST03	6-8 People	2110 x 4182 x 1074	£1,695
CST04	6-8 People	2110 x 2100 x 2110	£1,600
CST05	10-12 People	2110 x 3146 x 2110	£1,845
CST06	12-14 People	2110 x 4182 x 2110	£2,325
CST07	16-18 people	2110 x 5218 x 2110	£2,695

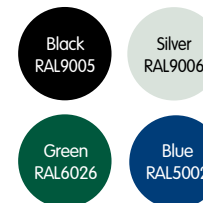

- Add perch seats for additional comfort, available in a choice of four standard RAL colours. Alternatively, request a price for non-standard colours to match your shelter (see page 12)
- Shelters are supplied surface mountable as standard, optional extended feet can be purchased for sub-surfacing

INSTALLATION

Our shelters, walkways and canopies are easy to install and come supplied with full assembly instructions. Alternatively, we have a team of experienced installers who can carry out the work for you. Contact our friendly sales team for a price on 0800 1777 052



Configuration Drawings



Visit NoButts.co.uk for all configurations





Model Shown: CSB08



DOMED 4-SIDED SMOKING SHELTER WITH ALUMINIUM ROOF

NEW

FEATURES & BENEFITS

- Spacious design 4-sided freestanding smoking shelter
- Attractive domed aluminium composite roof
- Creates a designated smoking area for your premises
- Compliant with Smoking Ban Legislation – Parliament Act 3368

OPTIONAL EXTRAS

- Cigarette bins available either freestanding and/or wall attached (see pages 15-17)
- Clearly indicate your shelter's purpose with designated smoking area signs (see page 17)
- Non-standard RAL colours to match your business colours and/ or existing surroundings
- Add perch seats for additional comfort, available in a choice of 4 standard RAL colours (see below)

SPECIFICATIONS

- Mild steel frame, zinc coated and supplied powder coated in your choice of standard RAL colour
- Aluminium composite roof (supplied in the same colour as shelter unless otherwise stated).
- Clear polycarbonate glazing is UV stabilised, it will not turn yellow or brittle in sunlight

INSTALLATION

Our shelters, walkways and canopies are easy to install and come supplied with full assembly instructions. Alternatively, we have a team of experienced installers who can carry out the work for you. Contact our friendly sales team for a price on 0800 1777 052



Model Shown: CSB02



Code	Capacity	H x L x W (mm)	Price Each
CSB02	2-3 people	2205 x 2110 x 1110	£1,240
CSB03	4-6 People	2205 x 3146 x 1110	£1,540
CSB04	7- 9 People	2205 x 4182 x 1110	£1,940
CSB08	6-8 People	2413 x 2110 x 2110	£1,740
CSB09	10-12 People	2413 x 3146 x 2110	£2,140
CSB10	12-14 People	2413 x 4182 x 2110	£2,540
CSB11	16-18 People	2413 x 5218 x 2110	£2,995

NO BUTTS[®] PERCH SEAT AND BENCH

Complements your smoking shelter

FEATURES & BENEFITS

- Sloping perch seat is ideal for short breaks

SPECIFICATIONS:

- Constructed from polyester powder coated mild steel
- 4 bolts are required to secure to surface base (see online)
- Supplied with a 5 year guarantee against rust & corrosion

ABH01ZC
Perch SeatBENCHZC
Bench

Code	H x L x W (mm)	Price Each
ABH01ZC	830 x 1000 x 300	£125
BENCHZC	710 x 1000 x 300	£125



Model Shown: AXPY03



APEX 4-SIDED SMOKING SHELTER WITH POLYCARBONATE ROOF

Freestanding smoking shelter with optional integrated seating

NEW

FEATURES & BENEFITS

- New stylish smoking shelter featuring pointed apex roof
- Roof section is made from clear polycarbonate which gives a light and airy feel
- Also available with aluminium composite roof section (see below for prices)
- Creates a designated smoking area for your premises
- Compliant with Smoking Ban Legislation – Parliament Act 3368

OPTIONAL EXTRAS

- Optional integrated seating available (see below)
- Cigarette bins available either freestanding and/or wall attached (see pages 15-17)
- Clearly indicate your shelter's purpose with designated smoking area signs (see page 17)
- Non-standard RAL colours to match your business colours and/ or existing surroundings

SPECIFICATIONS

- Mild steel frame, zinc coated and supplied powder coated in your choice of standard RAL colour
- Robust, clear cellular polycarbonate roofing
- Clear polycarbonate glazing is UV stabilised, it will not turn yellow or brittle in sunlight
- Aluminium composite roof supplied same colour as frame unless otherwise stated

INSTALLATION

Our shelters, walkways and canopies are easy to install and come supplied with full assembly instructions. Alternatively, we have a team of experienced installers who can carry out the work for you. Contact our friendly sales team for a price on 0800 1777 052

Polycarbonate Roof

Code	Capacity	H x L x W (mm)	Price Each
AXPY01	2-3 People	2324 x 2110 x 1110	£1,195
AXPY02	4-6 People	2324 x 3146 x 1110	£1,495
AXPY03	7-9 People	2324 x 4182 x 1110	£1,895
AXPY04	6-8 People	2450 x 2210 x 2110	£1,695
AXPY05	10-12 People	2450 x 3146 x 2110	£2,095
AXPY06	12-14 People	2450 x 4182 x 2110	£2,495
AXPY07	16-18 People	2450 x 5218 x 2110	£2,950

Code	Description	Price Each
IPS01	Optional Integrated Perch Seat	£50



Model Shown: AXCS01



Optional Extra: Integrated Perch Seat



Aluminium Roof

Code	Capacity	H x L x W (mm)	Price Each
AXCS01	2-3 People	2324 x 2110 x 1110	£1,295
AXCS02	4-6 People	2324 x 3146 x 1110	£1,595
AXCS03	7-9 People	2324 x 4182 x 2110	£1,995
AXCS04	6-8 People	2450 x 2110 x 2110	£1,795
AXCS05	10-12 People	2450 x 3146 x 2110	£2,195
AXCS06	12-14 People	2450 x 4182 x 2110	£2,595
AXCS07	16-18 People	2450 x 5218 x 2110	£3,095





Model Shown: CSM01

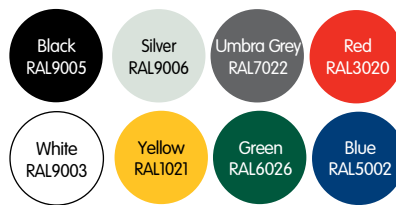

CORFE CANOPY

Ideal for creating cost-effective covered areas and for maintaining social distancing protocols

FEATURES & BENEFITS

- Can be used to create a designated smoking area for individuals or smaller groups
- Perfect for premises with limited floor space
- Frame is tough yet light, manufactured from 40mm x 40mm x 2mm steel tube
- Available in eight standard RAL colours
- Easy to assemble, simply bolts to the wall (fixings not included - see online)

SPECIFICATIONS

- Choose from clear polycarbonate or aluminium composite roof
- 4mm polycarbonate glazing, UV stabilised

INSTALLATION

Our shelters, walkways and canopies are easy to install and come supplied with full assembly instructions

Code	Description	L x W (mm)	Capacity	Price Each
CSM01	Clear Polycarbonate Canopy	2000 x 1000	3-5 people	£382.50
CSM02	Aluminium Composite Canopy	2000 x 1000	3-5 people	£400.50

SMOKERS CEASEFIRE

A low cost solution to cigarette litter

FEATURES & BENEFITS

- Freestanding design allows bin to be placed in the optimum location
- Extinguishes cigarettes easily and safely
- Features a high capacity collection bucket
- Unique design prevents the outpost from filling with rainwater
- Weather resistant and available in two colours

SPECIFICATIONS

- Polythene construction with galvanised steel collection bucket
- Optional anchor kit available to secure to the ground
- Weight: 6kg
- Capacity: 15 litre
- Dimensions: 978mm(H) x 419mm(Dia)



Code	Description	H x Dia (mm)	Finish	Price Each
SCF01	Smokers Ceasefire	978 x 419	Grey	£75.00
SCF02	Smokers Ceasefire	978 x 419	Black	£75.00
ANC1	Anchor Kit	-	-	£2.95

**BEST
SELLER**

**Only
£75.00
PER BIN**



Grey



Black



Model Shown: ANSSP1



SANDFORD CANOPY PORCH

Ideal for adding shelter to sites where space is limited

FEATURES & BENEFITS

- Creates a designated smoking area
- Compliant with Smoking Ban Legislation - Parliament Act 3368
- Ideal for smaller premises where floor space is limited
- Attaches easily to a wall
- Protects employees from the elements
- Lightweight structure is weather resistant and will not rust
- Also suitable for use as a waiting area or entrance porch

SPECIFICATIONS

- Domed roof made from reinforced fibreglass
- Maintenance free for 15 years and life maintained for 25 years

INSTALLATION

Our shelters, walkways and canopies are easy to install and come supplied with full assembly instructions

Code	Capacity	W x D (mm)	Price Each
ANSSP1	3-5 People	2100 x 1000	£795

ORIGINAL NO BUTTS[®] CIGARETTE BIN

Keep your entrance and smoking areas free from cigarette litter

FEATURES & BENEFITS

- Patented fire prevention baffle system extinguishes cigarette butts
- Stainless steel option is guaranteed for life
- Lockable double collection box deters vandals
- Available in mild steel construction with two powder coated finish options (see below)
- Encourages smokers to dispose of cigarettes responsibly and safely. With the No Butts[®] Bin, your entrances and designated areas will remain cigarette butt free



SPECIFICATIONS

- Back mounting plates and inner collection boxes: 304-grade stainless steel
- **Stainless Steel model: 1mm architectural grade Guaranteed for Life!**
- Painted models: 1mm Zintec, zinc plated mild steel, coated with epoxy polyester coating
- Painted models available in Antique Silver or Black Textured finishes
- Supplied with wall-mounted screw fixings
- Traditional ashtray but with all the benefits of the No Butts[®] Tower interior design
- Capacity: 2 litres

GUARANTEED FOR LIFE
All stainless steel No Butts Bins are guaranteed for life

Code	H x W x D (mm)	Capacity	Finish	Price Each
ANBB01	445 x 245 x 70	2 Ltr	Stainless Steel	£89.99
ANBB02	445 x 245 x 70	2 Ltr	Antique Silver	£69.99
ANBB04	445 x 245 x 70	2 Ltr	Black Textured	£69.99



Emptying the bin

Model Shown: ANBB01

Code	Description	Price Each
INBOX	Replacement Inner Collection Tray	£42.00
KEYGREEN	Replacement Keys x 2	£4.40

**BEST
SELLER****NO BUTTS® TOWER CIGARETTE BINS**

Freestanding, stylish and functional

FEATURES & BENEFITS

- Freestanding design makes it possible to place the bin in an ideal location
- Lockable double collection box, bins supplied with two keys
- Available in either stainless steel or mild steel powder coated in two finishes

SPECIFICATIONS

- Bin tops and inner collection boxes are manufactured from 1mm architectural grade stainless steel on all models
- Stainless steel variant body is manufactured from 1mm architectural grade and guaranteed for life
- Painted models: 1mm zintec, zinc plated mild steel with epoxy polyester coating. Available in Antique Silver or Black Textured finishes
- Can be easily bolted to the ground (see bottom price grid for anchor bolts)
- Capacity: 6.6 litres

PYRAMID TOP BIN:

Pyramid top prevents objects being placed on top and ensures the effectiveness of the bin is not compromised

**HOODED TOP BIN:**

Hooded top protects the bin from filling with water when placed in exposed locations

**FLAT TOP BIN:**

Flat top has the appearance of a traditional ashtray, yet has all the benefits of the No Butts® Tower interior design

**GUARANTEED FOR LIFE**

All stainless steel No Butts Bins are guaranteed for life

**Pyramid Top Bin**

Code	Description	H x W x D (mm)	Finish	Price Each
ATBH01	Pyramid Top Bin	800 x 200 x 200	Stainless Steel	£164.95
ATBH02	Pyramid Top Bin	800 x 200 x 200	Antique Silver	£134.95
ATBH03	Pyramid Top Bin	800 x 200 x 200	Green	£134.95
ATBH04	Pyramid Top Bin	800 x 200 x 200	Black Textured	£134.95
INNER	Replacement Inner Collection Tray	-	-	£42.00
KEY-MVM	Replacement Keys x 2	-	-	£3.50

Hooded Top Bin

Code	Description	H x W x D (mm)	Finish	Price Each
AHDD01	Hooded Top Bin	850 x 200 x 200	Stainless Steel	£164.95
AHDD02	Hooded Top Bin	850 x 200 x 200	Antique Silver	£134.95
AHDD03	Hooded Top Bin	850 x 200 x 200	Green	£134.95
AHDD04	Hooded Top Bin	850 x 200 x 200	Black Textured	£134.95
INNER	Replacement Inner Collection Tray	-	-	£42.00
KEY-MVM	Replacement Keys x 2	-	-	£3.50

Flat Top Bin

Code	Description	H x W x D (mm)	Finish	Price Each
AFLT01	Flat Top Bin	690 x 200 x 200	Stainless Steel	£164.95
AFLT02	Flat Top Bin	690 x 200 x 200	Antique Silver	£134.95
AFLT03	Flat Top Bin	690 x 200 x 200	Green	£134.95
AFLT04	Flat Top Bin	690 x 200 x 200	Black Textured	£134.95
INNER	Replacement Inner Collection Tray	-	-	£42.00
KEY-MVM	Replacement Keys x 2	-	-	£3.50
ANC1	Anchor Kit	-	-	£2.95



Visit NoButts.co.uk to see our full range of cigarette bins

BUDGET NO BUTTS® BIN

Encourages smokers to dispose of cigarettes responsibly outdoors

FEATURES & BENEFITS

- Patented fire prevention baffle system extinguishes cigarette butts quickly and safely
- Available in either stainless steel, or powder coated mild steel in a choice of two colours
- Capacity: 1.3 litres

SPECIFICATIONS

- Painted models available in Antique Silver or Black Textured finishes
- Easily emptied, simply slide the outer casing off
- Wall-mountable, supplied with screw fixings



Code	Description	Finish	H x W x D (mm)	Price Each
BBIN02	Budget No Butts Bin	Antique Silver	210 x 120 x 70	£35.95
BBIN04	Budget No Butts Bin	Black Textured	210 x 120 x 70	£35.95
BBIN01	Budget No Butts Bin	Stainless Steel	210 x 120 x 70	£49.95

SMOKING CONTROL SIGNS

Comply with legislation and display relevant smoking signs

Smoking Area Signs

Designated smoking area signs (NBAQ0027, NBAQ0014, NBAQ0061, NBAQ0042, NBAQ0048, NBAQ0007, NBAQ0029, NBAQ0038, NBAQ0071) and No smoking signs (NBAQ0002, NBAQ0037, NBAQ0052, NBAQ0002, NBAQ0038, NBAQ0071).

Electronic Cigarette Signs

Electronic cigarette signs (NBAQ2670, NBAQ2671, NBAQ2672, NBAQ2667, NBAQ2668, NBAQ2669, NBAQ2664, NBAQ2665, NBAQ2666, NBAQ2673, NBAQ2674, NBAQ2675).

ELITE SMOKERS CEASEFIRE

Control smoking litter with this contemporary style cigarette bin

FEATURES & BENEFITS

- Freestanding design means the bin can be placed in the optimum location
- Extinguishes cigarettes and allows easy disposal
- High capacity collection bucket
- Manufactured from a weather resistant material. Unique design means that the outpost will not fill with rainwater

SPECIFICATIONS

- Polyethylene construction with galvanised steel collection bucket
- Can be secured to the ground with optional fixing bolts
- Capacity: 15 litres
- Dimensions: 965mm(H) x 305mm(Dia)



EXTINGUISHES CIGARETTES QUICKLY & SAFELY



Code	Description	H x Dia (mm)	Finish	Price Each		
				1	2	3+
SCFE01-BLK	Elite Ceasefire	965 x 305	Grey	£135.00	£130.00	£125.00
SCFE01-GRY	Elite Ceasefire	965 x 305	Black	£135.00	£130.00	£125.00
ANC1	Anchor Kit	-	-	£2.95	-	-

Vehicle Sign

Vehicle signs (NBAQ0016, NBAQ0023, NBAQ0001, NBAQ0026, NBAQ0020, NBAQ0021) and No Smoking Signs (NBAQ0006, NBAQ0017, NBAQ0019).

Cycle Parking Signs

Cycle parking signs (NBAQ5266, NBAQ5267, NBAQ5400, NBAQ5401, NBAQ4186, NBAQ4187).

Size (mm)	Price Each		Size (mm)	Price Each	
	SA Vinyl	Rigid Plastic		SA Vinyl	Rigid Plastic
100 x 150	£1.50	£2.60	300 x 400	£5.20	£9.70
150 x 200	£2.15	£4.10	400 x 300	£5.20	£9.70
200 x 150	£2.15	£4.10	600 x 400	-	£14.20
200 x 300	£3.65	£6.45	450 x 150	£3.50	£4.40
300 x 100	£1.80	£3.55	600 x 200	£5.55	£7.70
300 x 200	£3.65	£6.45	600 x 450	£11.00	£16.95

How To Order:
Slate Product Code, Material (SA=Self Adhesive Vinyl, RP=Rigid Plastic) and Quantity of Signs

Model Shown: ATBH01



Model Shown: AHDD01



Model Shown: Custom

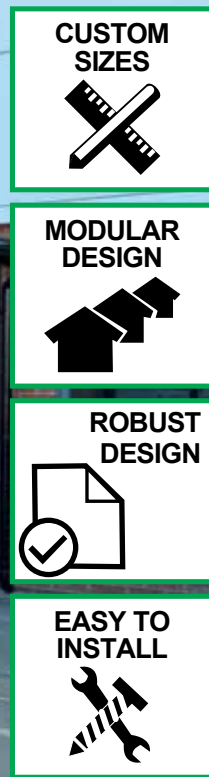

Model Shown: Custom



WINTERBOURNE WAVE SHELTER

Stylish wave design versatile shelter

FEATURES & BENEFITS

- Stylish wave design – great for adding the wow factor to any entrance area
- Ideal for buildings with low roof lines
- Can be used for outdoor dining or as a waiting shelter, ideal for maintaining social distancing protocols
- Popular freestanding shelter available in a range of standard and bespoke size options
- Easy to install or can be installed by our professional team

SPECIFICATIONS

- Steel structure, hot dipped galvanised to ISO 1461 2009 and powder coated in your choice of standard RAL colour
- Robust 16mm triple wall polycarbonate roofing
- Guttering and downpipes supplied as standard

OPTIONAL EXTRAS

- Side panels with various infill options
- Opal and coloured roofing

- Post protectors – can be any colour, often matching with the structure
- Non-standard RAL colours to match your business colours
- 100% recycled plastic seating – see pages 36-46

CUSTOM OPTIONS

Available in a choice of standard sizes. Alternatively, call for a price on a bespoke size option. Our modular design system means we can customise any shelter, walkway or canopy. Please contact our friendly sales team for a free quotation

INSTALLATION

Our shelters, walkways and canopies are easy to install and come supplied with full assembly instructions. Alternatively, we have a team of experienced installers who can carry out the work for you. Contact our friendly sales team for a price on 0800 1777 052

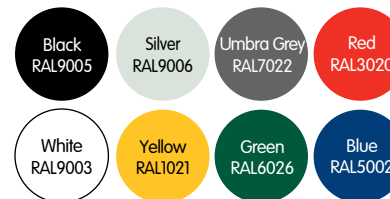

Code	H x L x W (mm)	Price Each
WWH033	2600 x 3050 x 3000	£2,800
WWH043	2600 x 3050 x 4000	£3,300
WWH034	2600 x 4050 x 3000	£3,650
WWH044	2600 x 4050 x 4000	£3,150
WWH035	2600 x 5050 x 3000	£3,850
WWH045	2600 x 5050 x 4000	£4,250



Visit NoButts.co.uk to see our full range of freestanding shelters

WINTERBOURNE FREESTANDING SHELTER

Ideal for covering walkways, or creating outdoor dining/waiting areas

FEATURES & BENEFITS

- Robust functional design – great for providing covered walkways linking two buildings or creating outdoor dining/waiting areas
- Curved or flat roofing designs can be accommodated
- Steelwork is galvanised and powder coated to chosen standard RAL colour
- Our modular system is easy to install or can be installed by our professional team

SPECIFICATIONS

- Steel structure, hot dipped galvanised to ISO 1461 2009 and powder coated in your choice of standard RAL colours
- Robust 16mm triple wall polycarbonate roofing as standard
- Guttering and downpipes supplied as standard

OPTIONAL EXTRAS

- Side panels with various infill options
- Opal and coloured roofing
- Post protectors – can be any colour, often matching with the structure

- Non-standard RAL colours to match your business colours and/or existing surroundings
- 100% recycled plastic seating & fencing (see pages 36-47)

CUSTOM OPTIONS

Available in a choice of standard sizes. Alternatively, call for a price on a bespoke size option. Due to our modular design system we can customise any shelter, walkway or canopy. Please contact our friendly sales team for a free quotation

INSTALLATION

Our shelters, walkways and canopies are easy to install and come supplied with full assembly instructions. Alternatively, we have a team of experienced installers who can carry out the work for you. Contact our friendly sales team for a price on 0800 1777 052

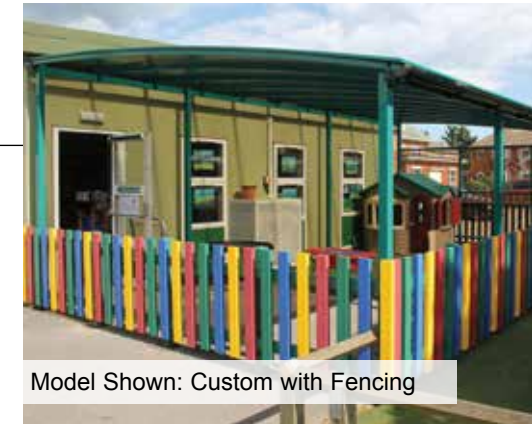

Model Shown: Custom with Fencing

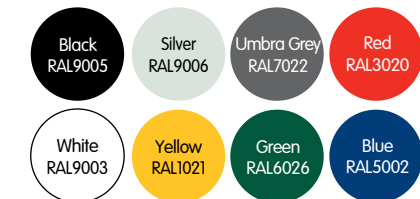

Code	H x L x W (mm)	Price Each
HWH033	2600 x 3000 x 3000	£2,550
HWH043	2600 x 3000 x 4000	£2,900
HWH034	2600 x 4000 x 3000	£3,050
HWH044	2600 x 4000 x 4000	£3,600
HWH035	2600 x 5000 x 3000	£3,400
HWH045	2600 x 5000 x 4000	£4,000





Model Shown: Custom

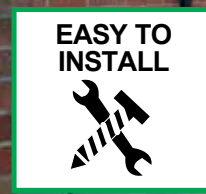
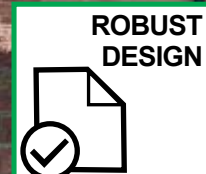
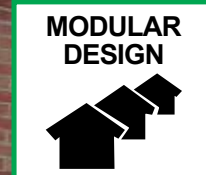
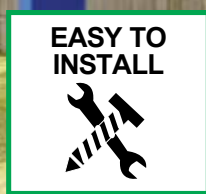
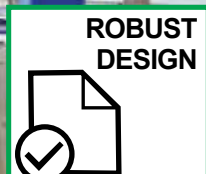
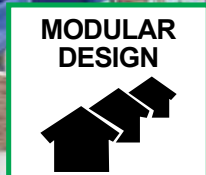

Model Shown: Custom



FREESTANDING QUEUE SHELTER

Perfect solution to keeping your visitors covered during adverse weather

FEATURES & BENEFITS

- Strong functional design – ideal for creating cover outside your buildings for people waiting outside
- Queue/entrance shelters help limit the number of people entering your premises at any one time, enabling businesses/schools to implement social distancing protocols
- Roof designed to allow rainwater to run into guttering
- Steelwork is powder coated only in a choice of standard RAL colours
- Easy to install modular system

- Opal and coloured roofing
- Post protectors – can be any colour often matching with the structure
- Non-standard RAL colours to match your business colours and/ or existing surroundings

CUSTOM OPTIONS

Available in a choice of standard sizes. Alternatively, call for a price on a bespoke size option. Due to our modular design system we have the ability to customise any shelter, walkway or canopy. Please contact our friendly sales team for a free quotation

INSTALLATION

Our shelters, walkways and canopies are easy to install and come supplied with full assembly instructions. Alternatively, we have a team of experienced installers who can carry out the work for you. Contact our friendly sales team for a price on 0800 1777 052

SPECIFICATIONS

- Steel structure, powder coated in your choice of standard RAL colours
- Robust 16mm triple wall polycarbonate roofing as standard
- Guttering and downpipes supplied as standard

OPTIONAL EXTRAS

- Side panels with various infill options

Visit www.nobutts.co.uk to see our full range of freestanding shelters



Model Shown: FQSH03

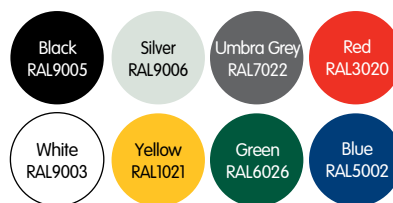

Code	H x L x W (mm)	Price Each
FQSH01	2600 x 2000 x 2000	£1,970
FQSH02	2600 x 3000 x 2000	£2,150
FQSH03	2600 x 4000 x 2000	£2,475
FQSH04	2600 x 5000 x 2000	£2,650
FQSH05	2600 x 6000 x 2000	£2,915

WINTERBOURNE WALL ATTACHED SHELTER

Ideal as a walkway or entrance cover

FEATURES & BENEFITS

- Wall attached (or partial wall attached) design – perfect for extending outdoor areas or creating a sheltered entrance area
- Steelwork is galvanised and powder coated to a choice of eight standard RAL colours
- Versatile wall attached shelter in a range of standard sizes and custom size options
- Our modular system is easy to install or can be installed by our professional team

SPECIFICATIONS

- Steel structure, hot dipped galvanised to ISO 1461 2009 and powder coated in your choice of standard RAL
- Robust 16mm triple wall polycarbonate roofing as standard
- Guttering and downpipes supplied as standard

OPTIONAL EXTRAS

- Side panels with various infill options
- Opal and coloured roofing
- Post protectors – can be any colour, often matching with the structure

- Non-standard RAL colours to match your business colours
- 100% recycled plastic seating & fencing (see pages 36-47)

CUSTOM OPTIONS

Available in a choice of standard sizes. Alternatively, call for a price on a bespoke size option. Due to our modular design system we can customise any shelter, walkway or canopy. Please contact our friendly sales team for a free quotation

INSTALLATION

Our shelters, walkways and canopies are easy to install and come supplied with full assembly instructions. Alternatively, we have a team of experienced installers who can carry out the work for you. Contact our friendly sales team for a price on 0800 1777 052



Model Shown: Custom



Code	H x L x W (mm)	Price Each
WBW033	2600 x 3000 x 3000	£2,050
WBW043	2600 x 3000 x 4000	£2,600
WBW034	2600 x 4000 x 3000	£2,400
WBW044	2600 x 4000 x 4000	£3,150
WBW035	2600 x 5000 x 3000	£2,650
WBW045	2600 x 5000 x 4000	£3,450





Model Shown: CNF23

Color selection options:

- Black RAL9005
- Silver RAL9006
- Umбра Grey RAL7022
- Red RAL3020
- White RAL9003
- Yellow RAL1021
- Green RAL6026
- Blue RAL5002

Guarantees:

- 15 YEARS NO MAINTENANCE GUARANTEE
- 25 YEARS LIFE MAINTAINED GUARANTEE

STEEPLE CANOPY

Wall attached shelter for covering entrances and walkways

FEATURES & BENEFITS

- Provides cover for individuals and queues waiting outside buildings
- Wall attached design gives maximum coverage from the elements whilst using minimum surface area
- Steelwork is galvanised and powder coated to your choice of standard RAL colour
- Flat pitched roof with curved steel supports
- Bolts to the wall, the posts must be sub-surfaced

SPECIFICATIONS

- Mild steel construction galvanised to ISO 461 2009 and polyester epoxy powder coated
- Tough 16mm clear twin wall polycarbonate glazing
- Clear polycarbonate glazing is UV stabilised so will not turn yellow or brittle in sunlight

INSTALLATION

Our shelters, walkways and canopies are easy to install and come supplied with full assembly instructions. Alternatively, we have a team of experienced installers who can carry out the work for you. Contact our friendly sales team for a price on 0800 1777 052

Code	Description	H (U/Side) x L x W (mm)	Price Each
CNF23	Steeple Canopy	2200 x 3000 x 2500	£1,650
CNF26	Steeple Canopy	2200 x 6000 x 2500	£2,650
CNF29	Steeple Canopy	2200 x 9000 x 2500	£3,650



Model Shown: CNL21

Code	Description	L x W (mm)	Price Each
CNL20	Chiswell Canopy	2000 x 2500	£1,050
CNL21	Chiswell Canopy	3000 x 2500	£1,300
CNL22	Chiswell Canopy	4000 x 2500	£1,650
CNL23	Chiswell Canopy	5000 x 2500	£1,850
CNL24	Chiswell Canopy	6000 x 2500	£2,150
CNL25	Chiswell Canopy	7000 x 2500	£2,400
CNL26	Chiswell Canopy	8000 x 2500	£2,700
CNL27	Chiswell Canopy	9000 x 2500	£2,950
CNL28	Chiswell Canopy	10000 x 2500	£3,250

CHISWELL ALUMINIUM CANOPY

Cost-effective wall attached canopy suitable for use over entrances or to provide shelter between buildings

FEATURES & BENEFITS

- Lightweight canopy ideal for positioning over entrances or between buildings
- Provides protection from the weather in adverse conditions

SPECIFICATION

- Manufactured from lightweight aluminium bars keeps load bearing on supportive walls to a minimum
- Powder coated in a choice of 8 RAL colours
- 100% corrosion resistant
- 16mm triple wall polycarbonate roofing as standard

OPTIONAL EXTRAS

- Add cigarette bins and signage for use as a smoking area (see pages 15-17)
- Non-standard RAL colour to match your business colours and/or existing surroundings

INSTALLATION

Our shelters, walkways and canopies are easy to install and come supplied with full assembly instructions. Alternatively we have a team of experienced installers who can carry out the work for you. Contact our friendly sales team for a price on 0800 1777 052

Color selection options:

- Black RAL9005
- Silver RAL9006
- Umбра Grey RAL7022
- Red RAL3020
- White RAL9003
- Yellow RAL1021
- Green RAL6026
- Blue RAL5002

Guarantees:

- 15 YEARS NO MAINTENANCE GUARANTEE
- 25 YEARS LIFE MAINTAINED GUARANTEE



Model Shown: KCS02ZC with end panels, powder coating, gates & racks

Build A Cycle Shelter In 5 Easy Steps

KIMMERIDGE CYCLE SHELTER

Stylish shelter that will protect your bicycles from all weathers

STEP 01

STEP 02

STEP 03

STEP 04

STEP 05

SELECT SIZE OF FRAME FROM 2M, 4M OR 6M LENGTHS

- Manufactured from 50mm x 50mm mild steel
- Galvanised
- Polycarbonate glazing (back/roof)

Code	Capacity	H x L x W (mm)	Price Each
KCS01ZC	3 Stands / 6 Cycles	2000 x 2050 x 1900	£915
KCS02ZC	6 Stands / 12 Cycles	2000 x 4050 x 1900	£1,250
KCS03ZC	9 Stands / 18 Cycles	2000 x 6050 x 1900	£1,710

CHOOSE YOUR FRAME COLOUR / FINISH

- Frame supplied galvanised only as standard. Add optional powder coated colour finish (choices below) - Please state colour when ordering

Color selection options:

- Black RAL9005
- Silver RAL9006
- Umбра Grey RAL7022
- Red RAL3020
- White RAL9003
- Yellow RAL1021
- Green RAL6026
- Blue RAL5002

Description	Colour Price	Galvanised Price
2 Metre Length	£255	-
4 Metre Length	£370	-
6 Metre Length	£522	-

ADD RACKS IF REQUIRED

- Manufactured from 40mm diameter mild steel
- Choose from galvanised only or galvanised and powder coated (same colour as shelter unless stated)

Compatible Shelter	Code	Capacity	Size H x L x W (mm)	Finish	Price Each
KCS01ZC (2M)	SCS9 (x1 Supplied)	3 Stands / 6 Cycles	820 x 1340 x 750	Galvanised	£100
KCS01ZC (2M)	SCS10 (x1 Supplied)	3 Stands / 6 Cycles	820 x 1340 x 750	Powder Coated	£175
KCS02ZC (4M)	SCS9 (x2 Supplied)	6 Stands / 12 Cycles	820 x 1340 x 750	Galvanised	£200
KCS02ZC (4M)	SCS10 (x2 Supplied)	6 Stands / 12 Cycles	820 x 1340 x 750	Powder Coated	£350
KCS03ZC (6M)	SCS9 (x3 Supplied)	9 Stands / 18 Cycles	820 x 1340 x 750	Galvanised	£300
KCS03ZC (6M)	SCS10 (x3 Supplied)	9 Stands / 18 Cycles	820 x 1340 x 750	Powder Coated	£525
No Racks	-	-	-	-	-

ADD END PANELS IF REQUIRED

- Polycarbonate end panels

No. of End Panels	Price Each
One Single End Panel	£135
Two End Panels (Pair)	£270
No End Panels	-

ADD SWING GATES

- Choose from galvanised only or galvanised and powder coated (same colour as shelter unless stated)
- Supplied with hasp and staple lock

Description	Colour Price	Galvanised Price
2 Metre Gates	£660	£530
4 Metre Gates	£1,190	£930
6 Metre Gates	£1,710	£1,330

Guarantees:

- 15 YEARS NO MAINTENANCE GUARANTEE
- 25 YEARS LIFE MAINTAINED GUARANTEE



In July 2021, the Department for Transport announced additional funding of £30m towards upgrades to the National Cycle Network. This significant investment comes as part of a commitment to make it easier for the British public to choose active forms of travel. Included in the plans are infrastructure improvement projects to bring in a new 'golden age for cycling'. You can help to encourage more people visiting your premises to choose alternatives to public transport by providing safe and secure cycle storage on site.

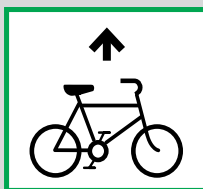

Model Shown: CCS01



Option To Add Customised Logo



Model Shown: BUCS01 & BUCS02

LOWEST PRICE EVER
£580

CORSCOMBE CYCLE SHELTER

Multipurpose shelter with corrugated metal back/roof, and option to personalise with own branding

FEATURES & BENEFITS

- Multipurpose shelter perfect for storing cycles or for use as a bin store
- The galvanised corrugated metal back panel hides the view from overlooking buildings
- Open front allows for easy access, whilst the freestanding design offers maximum versatility over location

- Signage to identify shelter as cycle parking bay (see page 17)
- Optional vinyl signs can be added to the end panels for own branding or to identify the purpose of the structure (contact our sales team for further details)
- End panels supplied separately (see price grid)

SPECIFICATIONS

- Corrugated galvanised steel covers the roof and back sections
- Optional end panels are made from clear polycarbonate and UV stabilised, it will not turn yellow or brittle in sunlight
- Designed to be used with Sheffield Toast Racks for up to ten bikes, or comfortably fit large wheelie bins

CUSTOM OPTIONS

Available in one standard size. Alternatively, call for a price on a custom size option. Due to our modular design system, we can customise any shelter, walkway or canopy. Please contact our friendly sales team for a free quotation

INSTALLATION

Our shelters are easy to install and come supplied with full assembly drawings. Alternatively, we have a team of experienced installers who can carry out the work for you. Contact our friendly sales team for a price on 0800 1777 052



Model Shown: CCS01 & BUCS02



OPTIONAL EXTRAS

- Galvanised cycle racks sold separately. Shelter can accommodate up to ten cycles (supplied as two- and three-stand racks)

Code	Description	Capacity	H x L x W (mm)	Price Each
CCS01	Cycle/ Bin Shelter	-	2496 x 3826 x 2310	£2,945
CCSEND	End Panel x 1	-	-	£145
BUCS02	Sheffield Toast Racks	10 cycles	820 x 2100 x 750	£175
LOGO	Customised Logo Sign	-	H975 x W849	POA

LUTTON BUDGET CYCLE SHELTER

Contemporary design – great for keeping cycles safe and secure

FEATURES & BENEFITS

- Modern design cycle shelters with space to store either six or ten bikes
- Versatile shelters can be supplied with or without racks
- Lowest priced cycle shelter for the perfect cost-saving option

OPTIONAL EXTRAS

- Galvanised cycle racks sold separately. Shelter can accommodate up to ten cycles (supplied as two- and three-stand racks)
- Signage to identify shelter as cycle parking bay (see page 17 or below)
- Add a perch seat for use as a waiting or smoking shelter (see page 12)
- Shelters are supplied surface mountable as standard, optional extended feet can be purchased for sub-surfacing

SPECIFICATIONS

- Zinc coated and powder coated in silver
- Roof/back panel is manufactured from clear 2mm polycarbonate. The transparent properties deter theft and vandalism
- Shelters are supplied with roof/back panel only, end panels are not supplied with this shelter
- Designed to be used with Sheffield Toast Racks (sold separately see price grid)

INSTALLATION

Our shelters are easy to install and come supplied with full assembly drawings. Alternatively, we have a team of experienced installers who can carry out the work for you. Contact our friendly sales team for a price on 0800 1777 052



Model Shown: BUCS06 & BUCS07

Silver RAL7035



Bicycle Parking

BICYCLE PARKING SIGN

Code	Size (mm)	Material	Price Each
NBAQ5400-R	300 x 400	Rigid Plastic	£9.70
NBAQ5400-S	300 x 400	Self Adhesive Vinyl	£5.20
NBAQ5401-R	400 x 600	Rigid Plastic	£14.20



Model Shown: Custom



Model Shown: KCC02ZC



LANSDOWNE CYCLE COMPOUND

High quality cycle storage compound with optional extras

FEATURES & BENEFITS

- Fantastic design shelter, the overhang allows for bicycles to be kept in enclosed or open areas
- Perfect for larger quantities of cycles. Alternatively, substitute racks for motorcycle space
- If required, the structure can be supplied without cycle racks for use as a vending or ticket machine shelter

SPECIFICATIONS

- Steel structure hot dipped galvanised to ISO 1461 2009 and powder coated in your choice of standard RAL colour
- Sheffield toast racks are supplied galvanised and powder coated
- Robust 16mm triple wall polycarbonate roofing as standard
- 4mm UV stabilised polycarbonate is face-fixed to structure
- Aluminium guttering and rainwater pipes
- Door closer included as standard

Code	Capacity	H x L x W (mm)	Price Each
LNWC01	10 Racks / 20 Cycles	2500 x 4000 x 4500	£11,995
LNWC02	16 Racks / 32 Cycles	2500 x 6000 x 4500	£14,995
LNWC03	22 Racks / 44 Cycles	2500 x 8000 x 4500	£17,795

*note the prices above exclude delivery and are subject to location, please contact our sales team for a cost

OPTIONAL EXTRAS

- Non-standard RAL colours to match your business colours
- Perch seats can be added for waiting shelters (see page 12), or recycled plastic furniture if using for outside dining (see pages 36-46)
- Signage to identify shelter as cycle parking compound (see page 17)
- Premium added features including solar lighting and keypad entry

INSTALLATION

Our shelters, walkways and canopies are easy to install and come supplied with full assembly instructions. Alternatively, we have a team of experienced installers who can carry out the work for you. Contact our friendly sales team for a price on 0800 1777 052



Optional Extras: Solar lighting and keypad entry

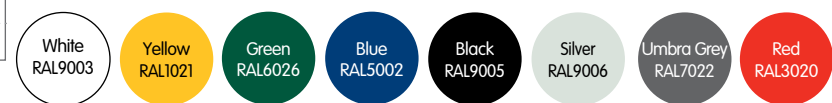

KIMMERIDGE CYCLE COMPOUND

Safe, secure storage for cycles and cycle accessories

FEATURES & BENEFITS

- Popular curved shelter. Modular design means that the structure can be easily extended
- Perfect for larger quantities of cycles. Alternatively, substitute racks for motorcycle space
- Choose from single or double sided variants, in a choice of three sizes to suit your cycle storage requirements

SPECIFICATIONS

- Mild steel frame, galvanised and powder coated in your choice of standard RAL colour
- Clear polycarbonate glazing is UV stabilised, it will not turn yellow or brittle in sunlight
- Gate supplied with staple and hasp lock
- Sheffield toast racks are supplied galvanised and powder coated

OPTIONAL EXTRAS

- Non-standard RAL colours to match your business colours and/or existing surroundings
- Alternative lock arrangements such as keypad or swipe card
- Signage to identify shelter as cycle parking compound (see page 17)

INSTALLATION

Our shelters, walkways and canopies are easy to install and come supplied with full assembly instructions. Alternatively, we have a team of experienced installers who can carry out the work for you. Contact our friendly sales team for a price on 0800 1777 052

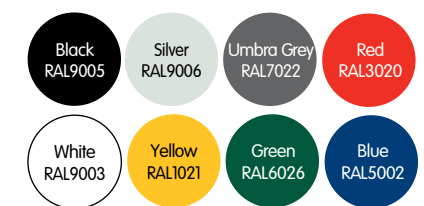

Configuration Drawings

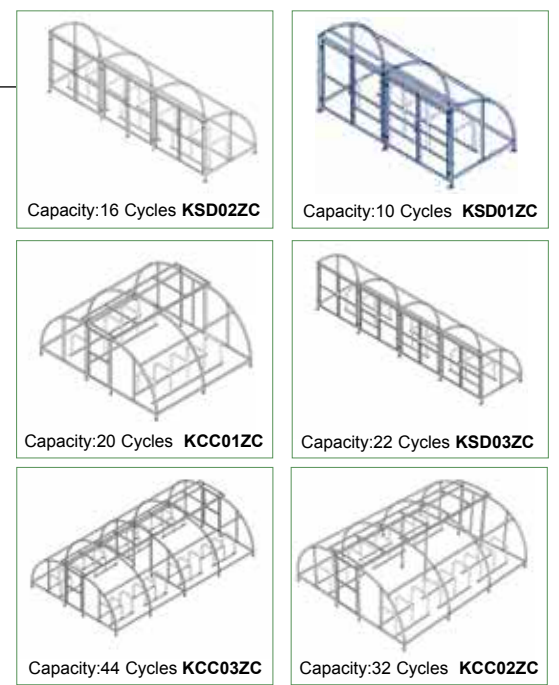

Single Sided - No Lock

Code	Description	Capacity	H x L x W (mm)	Price Each
KSD01ZC	Single Sided with Gate & Sheffield Toast Racks	5 Stands / 10 Cycles	1975 x 4060 x 1975	£3,430
KSD02ZC	Single Sided with Gate & Sheffield Toast Racks	8 Stands / 16 Cycles	1975 x 6060 x 1975	£4,737
KSD03ZC	Single Sided with Gate & Sheffield Toast Racks	11 Stands / 22 Cycles	1975 x 8060 x 1975	£6,742

Double Sided - Lock Included

Code	Description	Capacity	H x L x W (mm)	Price Each
KCC01ZC	Double Sided with Gate & Sheffield Toast Racks	10 Stands / 20 Cycles	2040 x 4060 x 4950	£5,730
KCC02ZC	Double Sided with Gate & Sheffield Toast Racks	16 Stands / 32 Cycles	2040 x 6060 x 4950	£6,970
KCC03ZC	Double Sided with Gate & Sheffield Toast Racks	22 Stands / 44 Cycles	2040 x 8060 x 4950	£8,230



Model Shown: SHS01 & SHS02

SHEFFIELD CYCLE STANDS

Popular, stylish stands at an incredible price

FEATURES & BENEFITS

- Each stand can accommodate two cycles, one on each side

SPECIFICATIONS

- Manufactured from steel tube
- Two finishes available - galvanised or galvanised and powder coated
- Choose from sub-surface or surface mounted (see price below)
- Available in eight standard colours. Non-standard RAL colours available on special order
- See bottom of the page for fixings (each surface mounted stand requires four bolts)

Surface Mounted

Code	Description	H x W (mm)	1-9	10+
SHS01	Sheffield Cycle Stand - Galvanised	750 x 760	£34.50	£33.50
SHS02	Sheffield Cycle Stand - Powder Coated	750 x 760	£40.99	£39.50

Sub-Surface

Code	Description	H x W (mm)	1-9	10+
SHS03	Sheffield Cycle Stand - Galvanised	1100 x 750	£36.99	£35.99
SHS04	Sheffield Cycle Stand - Powder Coated	1100 x 750	£45.50	£43.99



Model Shown: SCOOT2



Model Shown: SCS9

SHEFFIELD TOAST RACKS

Cost effective cycle storage, easy to install

FEATURES & BENEFITS

- Can accommodate up to six cycles

SPECIFICATIONS

- Manufactured from 50mm diameter mild steel tube
- Surface mounted for easy installation
- Multiple toast racks can be placed next to each other
- Available in eight standard colours. Non-standard RAL colours available on special order
- See bottom of the page for fixings (each rack requires four bolts)



Code	Capacity	Finish	H x L x W (mm)	Price Each
SCS11	2 Stands / 4 Cycles	Galvanised	770 x 772 x 773	£90.00
SCS12	2 Stands / 4 Cycles	Powder Coated	770 x 772 x 773	£135.00
SCS9	3 Stands / 6 Cycles	Galvanised	770 x 772 x 1495	£145.00
SCS10	3 Stands / 6 Cycles	Powder Coated	770 x 772 x 1495	£195.00

SINGLE & DOUBLE SIDED SCOOTER RACKS

Great single- or double-sided storage for scooters

FEATURES & BENEFITS

- Manufactured from tubular steel, see top right for colours
- Single-sided rack - storage of up to 10 scooters
- Double-sided rack - storage of up to 20 scooters
- Available in eight standard colours. Non-standard RAL colours available on special order

Scooter Racks

Code	Description	H x W (mm)	No. of Scooters	Price Each Was	Now
SCOOT4	Single Sided/ Galvanised	760 x 1990	10	£180	£120
SCOOT2	Single Sided/ Powder Coated	760 x 1990	10	£355	£250
SCOOT3	Double Sided/ Galvanised	760 x 1990	20	£210	£145
SCOOT1	Double Sided/ Powder Coated	760 x 1990	20	£395	£310

Fixings

Code	Description	Price Each
BTTARM	Fixing Bolt For Tarmac	£3.05
BTANCM1275	Anchor Fixing Bolt M10 For Concrete	£2.75
ARM01	Tamper Proof Bolt Cap	£2.50



See Page 21

JEWELL ACADEMY, BOURNEMOUTH

Project: Bespoke Wall Attached Winterbourne Shelter

Jewell Academy approached NBB Outdoors to provide an outside cover for a play area. Our team attended the school to discuss their requirements and expectations, and at this stage, it was decided a Wall Attached Winterbourne Shelter was the most suitable option. The finished project is a 13400mm wall attached walkway; Jewell Academy opted to have the shelter powder coated blue RAL5002 to match their school colour. Entrance Shelters and Walkways are ideal for covering outside space; they are multi-purpose, therefore whatever your requirement these shelters can be adapted to suit your needs.



See Page 26

BOURNEMOUTH UNIVERSITY, BOURNEMOUTH

Project: Bespoke Lansdowne Cycle Compound

Bournemouth University required a cycle compound for their new campus being built 2020-21. This structure would keep students' and staff bikes secure; it needed to include additional security features such as lighting and key card entry. Following their brief, we designed a structure that met their requirements and installed the shelter during the construction schedule.

Our cycle compounds are designed to store many bikes; they can also be adapted depending on your requirements. Furthermore, should you wish to use for another purpose, cycle racks can be substituted for outdoor machinery/ equipment or motorcycle storage.



See Page 19



KIMBOLTON PREPARATORY SCHOOL, HUNTINGDON

Project: Bespoke Free Standing Winterbourne Shelter

Kimbolton School is situated in Cambridgeshire, catering for approximately 1000 students, aged between 4 and 18 years old. They pride themselves in providing a caring, challenging environment in which all pupils are encouraged to fulfil their potential and are given opportunities to flourish in a wide variety of curricular and extra-curricular interests.

Over the past decade, the school have made many improvements to the facilities, including a new entrance building and library at the prep school, and a new Science and Maths Centre at the Senior School. NBB were contacted by SDC Builders on behalf of Kimbolton School. We were asked to supply shelters which would provide cover outside classrooms within the school. Our team proposed a detailed bespoke design which suited the modern look of the existing building.

The installation took place during the school holidays so that there would be no disruption to the pupils during school hours. The finished structure is comprised of three separate Freestanding Winterbourne Shelters, which are joined to make a long walkway to fit in perfectly with the building. The school opted for Silver RAL9006 which is one of our standard colours, and the roof is made from triple wall 16mm polycarbonate for a light and airy feel. The finished shelter looks fantastic and as it is covered by the 25 years life-maintained guarantee, it will continue to serve the school for many years to come!



CUSTOM SIZES

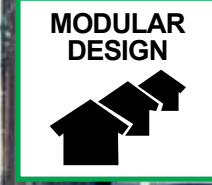

MODULAR DESIGN

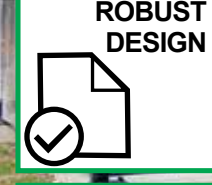

ROBUST DESIGN

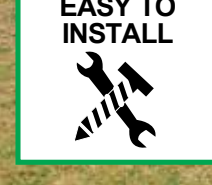

EASY TO INSTALL

Model Shown: Custom



WINTERBOURNE ENCLOSED SHELTER

Multi-use shelter perfect for utilising outside space

FEATURES & BENEFITS

- Provides cover for outside workspace/machinery, additional protection for walkways or storage for items such as buggies
- Fantastic space- and money-saving solution, fully customisable to include full-length side panelling, doors, roller shutters, and more

SPECIFICATIONS

- Steel structure, hot dipped galvanised to ISO 1461 2009 and powder coated in your choice of standard RAL colour
- 4mm polycarbonate sides face-fixed to structure
- Robust 16mm triple wall polycarbonate roofing as standard
- Guttering and down pipes supplied as standard

OPTIONAL EXTRAS

- Opal and coloured roofing
- Non-standard RAL colours to match your business colours
- 100% recycled plastic seating – see pages 36-46

CUSTOM OPTIONS

Available in a choice of standard sizes. Alternatively call for a price on a custom size option. Due to our modular design system, we have the ability to customise any shelter, walkway or canopy. Please contact our friendly sales team for a free quotation

INSTALLATION

Our shelters, walkways and canopies are easy to install and come supplied with full assembly instructions. Alternatively, we have a team of experienced installers who can carry out the work for you. Contact our friendly sales team for a price on 0800 1777 052



Model Shown: Custom with Roller Shutters

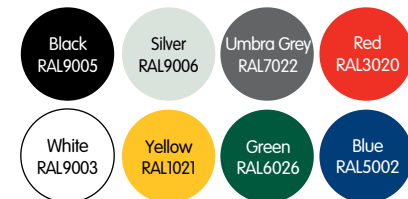

RECYCLED PLASTIC PICNIC TABLES



See page 37 for more details



Code	H x L x W (mm)	Price Each
CWSF033	2600 x 3000 x 3000	£6,650
CWSF043	2600 x 3000 x 4000	£7,180
CWSF034	2600 x 4000 x 3000	£7,150
CWSF044	2600 x 4000 x 4000	£9,060
CWSF035	2600 x 5000 x 3000	£8,600
CWSF045	2600 x 5000 x 4000	£9,400



Model Shown: CWB08



Model Shown: AXPW04



DOMED 4-SIDED WAITING SHELTER WITH ALUMINIUM ROOF

Perfect for controlling the number of people entering your building at any one time

NEW

FEATURES & BENEFITS

- 4-sided freestanding waiting shelter
- Attractive domed aluminium composite roof with trim finish
- Creates a designated waiting area for your premises

SPECIFICATIONS

- Mild steel frame, zinc coated and supplied powder coated in your choice of standard RAL colour
- Aluminium composite roof (supplied in the same colour as shelter unless otherwise stated)
- Full length side panels are made from clear polycarbonate glazing which is UV stabilised, it will not turn yellow or brittle in sunlight

OPTIONAL EXTRAS

- Non-standard RAL colours to match your business colours and/or existing surroundings
- Perch seats available in a choice of 4 RAL colours (see page 12)
- Shelters are supplied surface mountable as standard, optional extended feet can be purchased for sub-surfacing

INSTALLATION

Our shelters, walkways and canopies are easy to install and come supplied with full assembly instructions. Alternatively, we have a team of experienced installers who can carry out the work for you. Contact our friendly sales team for a price on 0800 1777 052



Code	Capacity	H x L x W (mm)	Price Each
CWB02	2-3 People	2205 x 2110 x 1110	£1,390
CWB03	4-6 People	2205 x 3146 x 1110	£1,690
CWB04	7-9 People	2205 x 4182 x 1110	£2,090
CWB08	6-8 People	2413 x 2110 x 2110	£1,890
CWB09	10-12 People	2413 x 3146 x 2110	£2,290
CWB10	12-14 People	2413 x 4182 x 2110	£2,690
CWB11	16-18 People	2413 x 5218 x 2110	£3,145

APEX 4-SIDED WAITING SHELTER WITH POLYCARBONATE ROOF

High quality shelter ideal for waiting areas outside your building

FEATURES & BENEFITS

- Stylish design shelter featuring a pointed apex roof, and full length polycarbonate side panels
- Roof section is made from clear polycarbonate which gives a light and airy feel
- Also available with aluminium composite roof section (see below for prices)

SPECIFICATIONS

- Mild steel frame, zinc coated and supplied powder coated in your choice of standard RAL colour
- Robust, clear cellular twin wall polycarbonate roofing
- Clear glazing is UV stabilised, it will not turn yellow or brittle in sunlight
- Aluminium composite roof supplied same colour as frame unless otherwise stated

OPTIONAL EXTRAS

- Non-standard RAL colours to match your business colours and/or existing surroundings
- Add additional perch seats, available in a choice of 4 RAL colours (see page 12)
- Shelters are supplied surface mountable as standard, optional extended feet can be purchased for sub-surfacing

INSTALLATION

Our shelters, walkways and canopies are easy to install and come supplied with full assembly instructions. Alternatively, we have a team of experienced installers who can carry out the work for you. Contact our friendly sales team for a price on 0800 1777 052

NEW



Model Shown: AXCW01



Polycarbonate Roof

Code	Capacity	H x L x W (mm)	Price Each
AXPW01	2-3 People	2324 x 2110 x 1110	£1,345
AXPW02	4-6 People	2324 x 3146 x 1110	£1,645
AXPW03	7-9 People	2324 x 4182 x 1110	£2,045
AXPW04	6-8 People	2450 x 2110 x 2110	£1,845
AXPW05	10-12 People	2450 x 3146 x 2110	£2,245
AXPW06	12-14 People	2450 x 4182 x 2110	£2,645
AXPW07	16-18 People	2450 x 5218 x 2110	£3,100

Aluminium Roof

Code	Capacity	H x L x W (mm)	Price Each
AXCW01	2-3 People	2324 x 2110 x 1110	£1,445
AXCW02	4-6 People	2324 x 3146 x 1110	£1,745
AXCW03	7-9 People	2324 x 4182 x 1110	£1,945
AXCW04	6-8 People	2450 x 2110 x 2110	£2,145
AXCW05	10-12 People	2450 x 3146 x 2110	£2,345
AXCW06	12-14 People	2450 x 4182 x 2110	£2,745
AXCW07	16-18 People	2450 x 5219 x 2110	£3,245



Model Shown: BRT03

BIN STORES

Aesthetically pleasing and durable bin storage solution

FEATURES & BENEFITS

- Secure freestanding structure designed to house wheelie bins or recycling units. Available to purchase in three different sizes
- Manufactured from 100% recycled plastic cladding and galvanised steel, this durable structure will last for many years without the need for annual maintenance
- Creates an aesthetically pleasing bin storage area, whilst also deterring vandals. Added signage makes it practical for distinguishing recycling purposes

SPECIFICATIONS

- Steelwork is galvanised as standard to protect against corrosion
- Lockable half open gates make it possible to securely lock away bins, whilst providing easy access for the disposal of waste
- Roofing is manufactured from galvanised corrugated metal
- 100% recycled plastic cladding will never rot, crack, splinter or corrode. Supplied in a choice of brown or grey
- Suits commercial bins of up to 1100 litre capacity (H1210mm x L1410mm x D110mm)

OPTIONAL EXTRAS

- Signs are available to distinguish recycling purposes (see price grid below)
- Option to powder coat frame, contact our sales team for a price

CUSTOM OPTIONS

Available in a choice of standard sizes. Alternatively, call for a price on a custom size option. Due to our modular design system, we can customise any shelter, walkway or canopy. Please contact our friendly sales team for a free quotation

INSTALLATION

Our shelters, walkways and canopies are easy to install and come supplied with full assembly instructions. Alternatively, we have a team of experienced installers who can carry out the work for you, contact our friendly sales team for a price on 0800 1777 052

Code	Description	Capacity	H x L x W (mm)	Price Each
BRT01	Storage Shelter	One Commercial Bin	1760 x 1594 x 1380	£1,995
BRT02	Storage Shelter	Two Commercial Bins	1755 x 3191 x 1380	£3,295
BRT03	Storage Shelter	Three Commercial Bins	1755 x 4788 x 1380	£4,395

Code	Description	L x W (mm)	Material	Price Each
NBAQ6070-R2	Sign - Cardboard Recycle Here	400 x 300	2mm Rigid Plastic	£14
NBAQ6076-R2	Sign - Plastic Recycle Here	400 x 300	2mm Rigid Plastic	£14
NBAQ6096-R2	Sign - General Waste Dispose Here	400 x 300	2mm Rigid Plastic	£14

WASTE MANAGEMENT SIGNS



AS LOW AS £1.60

See website for full range



PREMIUM RECYCLED PLASTIC LITTER BIN

Strong and durable refuse bins

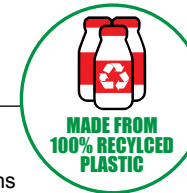

FEATURES & BENEFITS

- Premium litter bins designed to suit all applications
- Match with recycled plastic tables and benches to coordinate your outdoor areas (see pages 36-46)
- Place in high-traffic areas to reduce unsightly littering
- Made from environmentally friendly 100% recycled plastic
- No need for annual upkeep such as staining or painting
- Guaranteed maintenance-free for up to 25 years



Code	Description	Colour	H x D x W (mm)	Price Each
PY1094	Bin Without Lid	BLK,BRN	595 x 520 x 520	£200
PY1095	Bin Without Lid	GRY	595 x 520 x 520	£205
PY1097	Bin With Lid	BLK,BRN	783 x 520 x 520	£300
PY1098	Bin With Lid	GRY	783 x 520 x 520	£310
PY1123	Metal Bin Liner	GALVANISED	80L	£35

140L MAXI ENVIROBIN

Fantastic bins for use both indoors or outdoors



FEATURES & BENEFITS

- Clearly marked bins for recycling and general waste disposal
- Bin body is manufactured from environmentally friendly recycled plastic
- Double skin moulding throughout for exceptional strength
- Easy to use sack retention hoop system with a front opening door
- Lockable versions available online
- Capacity: 140L



Code	Description	Aperture	H x D x W (mm)	Price Each
PY1078	140L Maxi Envirobin	General Waste	1220 x 550 x 615	£375
PY1079	140L Maxi Envirobin	Aluminium Cans	1220 x 550 x 615	£375
PY1080	140L Maxi Envirobin	Plastic Bottles	1220 x 550 x 615	£375
PY1081	140L Maxi Envirobin	Confidential Paper	1220 x 550 x 615	£385
PY1082	140L Maxi Envirobin	Mixed Recycled	1220 x 550 x 615	£385





BEST SELLER

Model Shown: HAC05 in Brown



BEST SELLER

Model Shown: HAP01 in Brown

CONTRACT PICNIC TABLE

Great saving on bulk-purchases of the popular A-frame style table!

FEATURES & BENEFITS

- Exclusive offer on popular table - fantastic value for money when purchased in quantity of 5
- Ideal for high-traffic areas such as universities, holiday parks and activity centres
- Manufactured from 100% recycled plastic
- Easy to clean and maintenance free
- Overall seat height: 440mm
- Weight: 80kg
- Supplied with a parasol hole as standard (see page 50 for Parasols)



Model Shown: HAC05 in Black

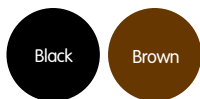

Code	Quantity	Colour	Seats	L x D x H (mm)	Price Each
HAC05	5 x Tables	BLK, BRN	6	1800 x 1460 x 780	£1,725

See below for optional fixing kits

Code	Description	Qty	Price Each
ARMKIT	Fixing Bolts For Tarmac	1	£6
CONKIT	Fixing Bolts For Concrete	1	£5



STANDARD PICNIC TABLE

Perfect for outdoor eating and social areas

FEATURES & BENEFITS

- Best-selling picnic table available in medium or large sizes
- Manufactured from 100% recycled plastic
- Guaranteed maintenance-free for 25 years
- Overall seat height: 440mm
- Medium table weighs 75kg and large tables weighs 90kg
- Supplied with a parasol hole as standard (see page 50 for Parasols)



See page 36 for optional fixing kits

Code	Colour	Size	Seats	L x D (mm)	Price Each 1	Price Each 2+
HAL01	BLK, BRN	Large	6	2000 x 1460	£520	£500
HAL02	GRY, GRN, BLU	Large	6	2000 x 1460	£595	£570
HAL03	MULTI	Large	6	2000 x 1460	£625	£605

Best-Selling Bulk Saving!
Buy 3 Black or Brown Picnic Tables For Just **£1,050**

Undercarriage supplied in black for coloured options

Code	Colour	Size	Seats	L x D x H (mm)	1-2	3-9	10-24	25+
HAP01	BLK, BRN	Medium	4	1500 x 1460 x 780	£385	£350	£330	£320
HAP02	GRY, GRN, BLU	Medium	4	1500 x 1460 x 780	£445	£415	£400	£385
HAP03	MULTI	Medium	4	1500 x 1460 x 780	£455	£425	£410	£395



Model Shown: HAL01 in Brown



Model Shown: HAP02 in Grey

**BEST
SELLER**



Model Shown: PY1019



TWO PERSON PICNIC TABLE

Perfect for maintaining social distancing protocols

FEATURES & BENEFITS

- Ideal for outdoor dining in pub gardens, workplace break areas or schools
- Manufactured from 100% recycled plastic, can be wiped clean between uses for simple infection control
- Robust and made to last, guaranteed for 25 years
- Completely maintenance free, and will never rot, splinter or corrode
- Weight: 43kg



Best-Selling Bulk Saving!
Buy 3 Brown Picnic Tables For Just **£885**

See page 36 for optional fixing kits

Code	Colour	Seats	L x D x H (mm)	1-2	3-9	10-24	25+
PY1018	BRN	2	1500 x 600 x 730	£315	£295	£280	£265
PY1019	GRY	2	1500 x 600 x 730	£335	£325	£305	£290



Model Shown: HSP01 in Brown



SQUARE PICNIC TABLE

Spacious picnic table provides seating for up to eight people

FEATURES & BENEFITS

- Sleek angular design picnic table, perfect for all manner of applications and settings
- Manufactured from 100% recycled plastic
- Strong and wear-resistant material will never rot
- Overall seat height: 440mm
- Weight: 105kg
- Supplied with a parasol hole and built-in base as standard (see page 50 for Parasols)

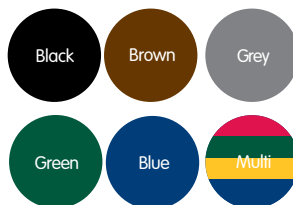

Undercarriage supplied in black for coloured options

Best-Selling Bulk Saving!
Buy 3 Black or Brown Picnic Tables For Just **£2,190**

See page 36 for optional fixing kits

Code	Description	Seats	L x D x H (mm)	Price Each			
				1-2	3-9	10-24	25+
HSP01	BLK,BRN	8	2000 x 2000 x 780	£740	£730	£715	£700
HSP02	BLU,GRN,GRY	8	2000 x 2000 x 780	£750	£740	£730	£720
HSP03	MULTI	8	2000 x 2000 x 780	£760	£750	£740	£730



Model Shown: HOP03 in Black

OCTAGONAL PICNIC TABLE

Robust and eco-friendly picnic table guaranteed for 25 years!

FEATURES & BENEFITS

- This popular design picnic table will suit any outdoor eating/break area and is great for high-traffic locations
- The 100% recycled plastic material is manufactured to have an attractive wood grain effect
- Overall seat height: 440mm
- Weight: 95kg
- Supplied with a parasol hole and built-in base as standard (see page 50 for Parasols)



Model Shown: HOP05



Undercarriage supplied in black for coloured options

Best-Selling Bulk Saving!
Buy 5 Black or Brown Picnic Tables For Just **£3,575**

See page 36 for optional fixing kits

Code	Description	Seats	L x D x H (mm)	Price Each				
				1-4	5-9	10-14	15-24	25+
HOP03	BLK,BRN	8	2000 x 2000 x 780	£730	£715	£705	£690	£675
HOP04	GRY, GRN, BLU	8	2000 x 2000 x 780	£735	£725	£715	£695	£685
HOP05	MULTI	8	2000 x 2000 x 780	£745	£725	£715	£705	£695





Model Shown: FHCY01

TWO / FOUR SEATER CANOPY

Perfect for outdoor locations in pubs/bars, schools and workplaces

FEATURES & BENEFITS

- Make use of your outside areas all year round, with canopies manufactured from zinc coated steel and 100% recycled plastic
- The recycled plastic seating will never rot, splinter or corrode
- Easy to sanitise, seats and table simply wipe clean between uses
- Steel frame is zinc coated and made to withstand adverse weather
- Clear polycarbonate roof gives a light and airy feel
- Extremely low maintenance and guaranteed to last



Model Shown: FHCY02

See below for optional fixing kits

Code	Description	Seats	L x D x H (mm)	Price Each
FHCY01	Four Seater Canopy	4	2000 x 1500 x 1981	£760
FHCY02	Two Seater Canopy	2	1380 x 660 x 1981	£445

Code	Description	Qty	Price Each
ARMKIT	Fixing Bolts for Tarmac	1 Kit	£6
CONKIT	Fixing Bolts for Concrete	1 Kit	£5

Black
RAL9005

Brown



HEAVY DUTY OCTAGONAL PICNIC TABLE

Heavy duty version of our octagonal picnic table

FEATURES & BENEFITS

- Manufactured from 100% recycled plastic
- Extremely robust and sturdy with reinforced legs
- Rot, splinter and corrosion resistant
- Overall seat height: 440mm
- Overall table height: 740mm
- Weight: 112kg
- Supplied with parasol hole and built-in base as standard (see page 50 for Parasols)



See page 40 for optional fixing kits

Code	Colour	Size	Seats	L x W x H (mm)	Price Each
PY056	BRN	Medium	8	2000 x 2000 x 740	£750

HEAVY DUTY PICNIC TABLE

Heavy duty version of our standard picnic table

FEATURES & BENEFITS

- Manufactured from 100% recycled plastic
- Robust and durable design, with reinforced legs
- Will never rot, splinter or corrode
- Overall seat height: 440mm
- Overall table height: 780mm
- Medium table weight: 92kg
- Large table weight: 95kg
- Supplied with parasol hole as standard (see page 50 for Parasols)



See page 40 for optional fixing kits

Code	Colour	Size	Seats	L x W x H (mm)	Price Each
PY059	BRN	Medium	4	1495 x 1460 x 780	£475
PY080	BRN	Large	6	1995 x 1460 x 780	£590



Model Shown: PY056



Model Shown: PY059





Model Shown: HOJ03



JUNIOR OCTAGONAL PICNIC TABLE

Smaller version of our popular octagonal table

FEATURES & BENEFITS

- Made from 100% recycled plastic
- Suitable for juniors and perfect for use in playgrounds
- Seat height is 388mm and table height is 704mm
- Supplied with parasol hole and built-in base as standard (see page 50 for Parasols)



Undercarriage supplied in black for coloured options

Best-Selling Bulk Saving!
Buy 3 Black or Brown Picnic Tables For Just **£3,090**

See page 40 for optional fixing kits

Code	Colour	L x W x H (mm)	Price Each	
			1-5	6+
HOJ01	BLK,BRN	2000 x 2000 x 704	£610	£515
HOJ02	GRY,GRN,BLU	2000 x 2000 x 704	£620	£595
HOJ03	MULTI	2000 x 2000 x 704	£630	£605

JUNIOR PICNIC TABLE

Perfect for outside play areas, nurseries and crèches

FEATURES & BENEFITS

- Manufactured from 100% recycled plastic
- Strong, durable, wear-resistant and will not rot
- Seat height is 380mm and table height is 700mm
- Supplied with a parasol hole as standard for medium tables (see page 50 for Parasols)
- Small table weighs 53kg and medium table weighs 62kg



Undercarriage supplied in black for coloured options

Best-Selling Bulk Saving!
Buy 3 Black or Brown Picnic Tables For Just **£990**

See page 40 for optional fixing kits

Code	Description	Seats	Size	L x D x H (mm)	Price Each	
					1-2	3+
HJP01	BLK,BRN	Small	4-6	1200 x 1200 x 700	£350	£330
HJP02	GRY,GRN,BLU	Small	4-6	1200 x 1200 x 700	£355	£340
HJP03	MULTI	Small	4-6	1200 x 1200 x 700	£370	£350
HJP04	BLK,BRN	Med	6-8	1500 x 1200 x 700	£355	£340
HJP05	GRY,GRN,BLU	Med	6-8	1500 x 1200 x 700	£375	£350
HJP06	MULTI	Med	6-8	1500 x 1200 x 700	£375	£355



Model Shown: HJP06



WHEELCHAIR ACCESS PICNIC TABLE

Great quality picnic table customised to provide space for wheelchairs

FEATURES & BENEFITS

- A-frame picnic table adapted to allow space for wheelchairs
- Made from 100% recycled plastic with a wood grain effect
- Seat height is 440mm and table height is 780mm
- Supplied with a parasol hole as standard (see page 50 for Parasols)



Undercarriage supplied in black for coloured options

Code	Colour	Size	L x D (mm)	Weight (kg)	Price
DMP01	BLK,BRN	Medium	1500 x 1460	68	£410
DMP02	BLU,GRN,GRY	Medium	1500 x 1460	68	£460
DMP03	MULTI	Medium	1500 x 1460	68	£485
DMP04	BLK,BRN	Large	2000 x 1460	80	£495
DMP05	BLU,GRN,GRY	Large	2000 x 1460	80	£555
DMP06	MULTI	Large	2000 x 1460	80	£610



Model Shown: DMP01 in Brown



WHEELCHAIR ACCESS OCTAGONAL PICNIC TABLE

Popular Octagonal Picnic Table adapted for wheelchair users

FEATURES & BENEFITS

- Provide seating for all with the spacious octagonally shaped picnic table with access for wheelchair users
- Can comfortably accommodate most wheelchair specifications
- The 100% recycled plastic material is manufactured to have a wood grain effect
- Strong, durable and wear resistant
- Seat height is 440mm and table height is 780mm
- Supplied with a parasol hole and built-in base as standard (see page 50 for Parasols)



Undercarriage supplied in black for coloured options

Code	Colour	L x D (mm)	Weight (kg)	Price
DOP01	BLK,BRN	2000 x 2000 x 780	88	£705
DOP02	GRY,GRN,BLU	2000 x 2000 x 780	88	£715
DOP03	MULTI	2000 x 2000 x 780	88	£715



Model Shown: DOP02 in Grey





Model Shown: PY007 in Brown

CAPTAIN'S TREBLE / DOUBLE SEAT

Our most popular outdoor seat

FEATURES & BENEFITS

- Best-selling design bench will complement all manner of outdoor settings
- Manufactured from 100% recycled plastic
- Wear-resistant and guaranteed for many years
- Manufactured to have an attractive wood grain effect
- Does not splinter and is resistant to insects & bacteria
- UV resistant and will not fade
- Double Seat is 1195mm in length (1364mm including arms)
- Treble Seat is 1495mm in length (1671mm including arms)
- Seat height: 435mm

Best-Selling Bulk Saving!
Buy 4 Black or Brown Seats For Just **£1,000**

Code	Description	Colour	Seats	L x D x H (mm)	Weight (kg)	Price Each	
						1-3	4+
PY007	Treble Seat	BLK,BRN	3	1671 x 650 x 895	36	£275	£250
PY008	Treble Seat	GRY	3	1671 x 650 x 895	36	£290	£275
PY010	Double Seat	BLK,BRN	2	1364 x 650 x 895	28	£195	£180
PY011	Double Seat	GRY	2	1364 x 650 x 895	28	£215	£205



BEST SELLER

PARK SEAT WITH BACK

Strong and durable outside seat

- Best-selling Park Seat, perfect for all manner of applications and settings
- Recycled plastic seats wipe clean for straightforward infection control
- Guaranteed for up to 25 years maintenance free
- Made using 100% recycled plastic solid moulded legs and seat/back slats
- 1200mm length seat has two legs, whilst 1500mm and 2000mm seats have three legs
- Will never rot, crack or splinter
- Seat height: 490mm



Code	Colour	Seats	L x D x H (mm)	Weight (kg)	Price Each
PBE07	BLK,BRN	2	1200 x 440 x 870	70	£300
PBE08	GRY	2	1200 x 440 x 870	70	£310
PBE01	BLK, BRN	3	1500 x 440 x 870	95	£440
PBE02	GRY	3	1500 x 440 x 870	95	£460
PBE03	BLK,BRN	4	2000 x 440 x 870	120	£500
PBE04	GRY	4	2000 x 440 x 870	120	£510

BACKLESS BENCH

Incredibly low cost seating solution

FEATURES & BENEFITS

- Manufactured from 100% recycled plastic
- Available in a choice of three standard lengths
- Will never rot, splinter or corrode
- Guaranteed for up to 25 years maintenance free
- Junior Backless Bench also available (see online)
- Seat height: 415mm



Best-Selling Bulk Saving!
Buy 5 Black or Brown Benches For Just **£625**

Code	Colour	L x D x H (mm)	Price Each	
			1-4	5+
BKB01	BLK,BRN	1200 x 305 x 415	£140	£125
BKB04	GRY	1200 x 305 x 415	£150	£130
BKB02	BLK,BRN	1500 x 305 x 415	£150	£130
BKB05	GRY	1500 x 305 x 415	£175	£150
BKB03	BLK,BRN	2000 x 305 x 415	£195	£180
BKB06	GRY	2000 x 305 x 415	£205	£195



Model Shown: PBE01 in Brown



Model Shown: BKB02 in Brown

BEST SELLER

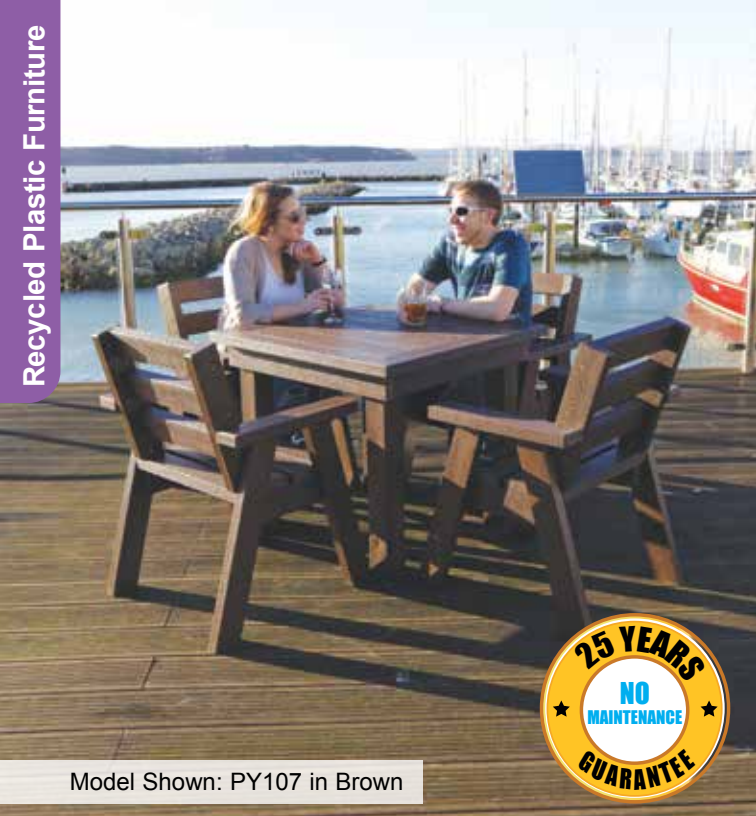

BOSUN'S TABLE AND CHAIRS SET

Perfect for outdoor areas in pubs and bars

FEATURES & BENEFITS

- Traditional design manufactured with an attractive woodgrain effect to complement any outside area
- Choose from two seating options – buy as a complete table and chairs set or individually (see below)
- Choose from Bosun's Chairs (without arms) or Captain's Chairs (with arms)
- Bosun's and Captain's Chairs available separately (see online)
- Overall table height: 760mm
- Supplied with a parasol hole as standard (see page 50 for Parasols)



Model Shown: PY107 in Brown

Code	Description	Size	Colour	Seats	Table L x W (mm)	Chair W x D (mm)	Weight (kg)	Price Each
PY104	Table with Bosun's Chairs	Large	BLK,BRN	4	900 x 900	500 x 435	130	£1,055
PY105	Table with Bosun's Chairs	Large	GRY	4	900 x 900	500 x 435	130	£1,095
PY107	Table with Captain's Chairs	Large	BLK,BRN	4	900 x 900	680 x 650	126	£875
PY108	Table with Captain's Chairs	Large	GRY	4	900 x 900	680 x 650	126	£895

Code	Description	Size	Colour	L x W (mm)	Weight (kg)	Price Each
PY156	Bosun's Table Only	Large	BLK,BRN	900 x 900	46	£350
PY157	Bosun's Table Only	Large	GRY	900 x 900	46	£375



CREW'S MESS SET

Classic rectangular table available with or without chairs

FEATURES & BENEFITS

- Made from environmentally friendly 100% recycled plastic
- Does not require annual maintenance and is easy to clean
- Captain's Chairs available separately (see online)
- Central leg support adds additional strength
- Overall table height: 760mm
- Supplied with a parasol hole as standard (see page 50 for Parasols)



Model Shown: PY083 in Brown

Code	Colour	Seats	Table L x W (mm)	Chair WxD (mm)	Price Each
PY490	BLK,BRN	6	1760 x 1200	680 x 650	£1,750
PY083	BLK,BRN	8	1760 x 1200	680 x 650	£2,045
PY491	GRY	6	1760 x 1200	680 x 650	£1,825
PY084	GRY	8	1760 x 1200	680 x 650	£2,155

Code	Colour	Seats	L x W (mm)	Weight (kg)	Price Each
PY034	BLK,BRN	-	1760 x 1200	103	£800
PY035	GRY	-	1760 x 1200	103	£850



PICKET FENCING

Maintenance free fencing will never rot, splinter or corrode

FEATURES & BENEFITS

- Supplied as pickets and posts, optional gates can also be accommodated. See full offering online, or contact our team on freephone 0800 1777 052 for a free no obligation quotation



Code	Description	H x L (mm)	Colour	1	2+
PY962	Post	(H) 1500	BLK,BRN	£55	£40
PY964	Picket Fence Panel	1000 x 1800	BLK,BRN	£305	£210
PY965	Picket Fence Panel	1000 x 1800	BLU,GRN,GRY	£315	£225
PY928	Picket Fence Panel	1000 x 1800	MULTI	£335	£245



HEAVY DUTY RAISED BEDS

Environmentally friendly raised beds

FEATURES & BENEFITS

- Manufactured from 100% recycled plastic
- Will never rot, corrode or splinter
- Heavy duty corners and reinforced struts for extra strength
- Raised beds are supplied bottomless for placement on soil or grass

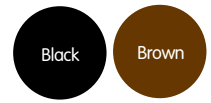

Code	Colour	L x D x H (mm)	Price Each
PY710	BLK,BRN	1220 x 1220 x 140	£130
PY711	BLK,BRN	1220 x 1220 x 280	£170
PY712	BLK,BRN	1220 x 1220 x 420	£235
PY713	BLK,BRN	2400 x 1220 x 140	£140
PY714	BLK,BRN	2400 x 1220 x 280	£240
PY715	BLK,BRN	2400 x 1220 x 420	£340
PY716	BLK,BRN	3000 x 1220 x 140	£165
PY717	BLK,BRN	3000 x 1220 x 280	£295
PY718	BLK,BRN	3000 x 1220 x 420	£410

STANDARD RAISED BEDS

Plant vegetables and/or herbs

FEATURES & BENEFITS

- Manufactured from 100% recycled plastic
- Will never rot, corrode or splinter
- Strong and robust, will withstand all weather conditions
- Raised beds are supplied bottomless for placement on soil or grass

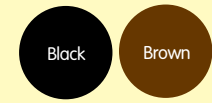

Code	Colour	L x D x H (mm)	Price Each
PY719	BLK,BRN	1220 x 1220 x 140	£100
PY720	BLK,BRN	1220 x 1220 x 280	£140
PY721	BLK,BRN	1220 x 1220 x 420	£190
PY722	BLK,BRN	2400 x 1220 x 140	£130
PY723	BLK,BRN	2400 x 1220 x 280	£185
PY724	BLK,BRN	2400 x 1220 x 420	£290
PY725	BLK,BRN	3000 x 1220 x 140	£145
PY726	BLK,BRN	3000 x 1220 x 280	£250
PY727	BLK,BRN	3000 x 1220 x 420	£355



Model Shown: FAF01

FINE FLUTED ANTI-FATIGUE MAT

Increase comfort & productivity in your work areas

FEATURES & BENEFITS

- Reduce fatigue for your workers standing for long periods of time with this specialised anti-fatigue mat
- Durable and robust anti-fatigue floor mat is ideal for use in assembly areas in dry industrial and commercial workplaces
- Manufactured from durable PVC
- The fluted surface offers foot grip and support



Code	Size (cm)	Depth (cm)	Price Each
FAF01	60 x 90	1.00	£48.00
FAF02	90 x 150	1.00	£110.00
FAF03	90 x 300	1.00	£210.00

CABLE MAT

Prevent accidents caused by loose cables

FEATURES & BENEFITS

- Avoid unnecessary trips and falls caused by loose leads and cables within your office or classroom with cable cover matting
- Cable mats hide and tidy unsightly electrical leads over a carpeted area
- Specially designed recess ensures cables are held securely and safely beneath the mat
- High-visibility chevrons highlight the potential hazard
- The 100% nitrile rubber backing prevents the mat from moving

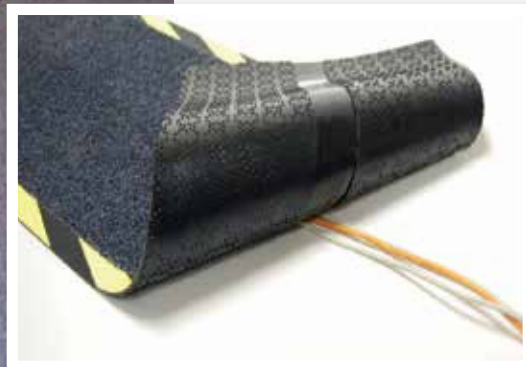

Code	Size (cm)	Price Each
CABM	40 x 121	£29.00

AQUASORB MAT

An effective barrier against dirt and moisture entering your premises

FEATURES & BENEFITS

- Tough, long lasting mat with raised waffle design which removes dirt and moisture - can hold up to 6 litres per square metre
- Decalon fibres bonded to tough rubber base
- Gripped backing minimises movement on all surfaces and raises mat off the floor to allow drying underneath when newly mopped
- Extremely tough solid rubber borders - ideal for high-traffic areas



Model Shown: MTA0009 in Charcoal

Code	Size (cm)	Depth (cm)	Was	Price Each	
				1-2	3+
MTA0008	60 x 90	1.05	£32.00	£19.00	£17.50
MTA0009	80 x 120	1.05	£60.00	£36.00	£32.50
MTA0010	90 x 150	1.05	£70.00	£46.00	£43.00
MTA0011	120 x 180	1.05	£90.00	£71.00	£67.00



Model Shown: MTA0011 in Brown



RINGMAT OCTOMAT

Extremely tough rubber matting for outdoor use

FEATURES & BENEFITS

- Highly durable entrance mat ideal for use outdoors
- Raised surface design ensures grip in wet conditions while scraping away dirt and debris
- Large holes allow dirt and debris to fall through, keeping it trapped
- Option to add brush inserts for enhanced scraping, ideal for heavy duty environments
- Connectors are available to link matting for covering large areas (one every 25cm)

How it works



To order: please state code, colour and quantity

Code	Description	Size (cm)	Depth (cm)	Price Each	
				Was	1+
MTA0089	Ringmat Octomat	50 x 100	2.22	-	£30.00
MTA0090	Ringmat Octomat	100 x 150	2.22	£67.00	£56.00
MTA0087	Ringmat Octomat Connector	-	-	-	£2.00
MTA0088	Ringmat Octomat Brush insert	-	-	-	£2.50

Model Shown: MTA0090

BEST SELLER

NEW LOWER PRICES SAVE UP TO 40%

NEW LOWER PRICE (MTA0090) SAVE 16%



Model Shown: PARS01 in Grey

WOODEN GARDEN PARASOL

Perfect for providing shade to customers and staff

NEW

FEATURES & BENEFITS

- Strong construction with a hardwood pole and framework provides reliable protection in all weathers
- Water-repellent polyester canvas
- Simple pulley-operated opening system with a choice of three open positions
- Max Diameter: 2.68m
- Pole Diameter: 38mm
- Height: 2.49m

Black

Grey

Code	Description	Colour	Price Each	
			1-4	5+
PARS01	Wooden Garden Parasol	BLK, BLK/GRY	£49.99	£46.49
PARS02	12kg Parasol Base	BLK	£29.99	£27.99



HERSCHEL HAVANA UNDER TABLE INFRARED HEATER

Portable patio heater, ideal for positioning under outdoor tables

NEW

FEATURES & BENEFITS

- Freestanding, compact heater produces instant localised warmth to those nearby
- Easy to operate, simply plug in and switch on
- CE marked, IEC 60335-1; 60335-2-30 Electrical & Construction Safety Tested and RoHS compliant
- More outdoor heater varieties available online

Black

Code	Weight (kg)	Colour	Price Each	
			1-4	5+
PATIO006	4.2	BLK	£150.00	£138.90



CANTILEVER HANGING PARASOL

Perfect for providing shade in outdoor dining areas and beer gardens

NEW

FEATURES & BENEFITS

- Versatile cantilever design can be used for all manner of applications and settings
- Powder coated tubular steel construction with cream polyester canopy, featuring a 30+ UPF rating
- Crank handle with variable height and angle settings
- Max Diameter: 3m
- Height: 2.4m

Cream

Code	Description	Colour	Price Each
PARS03	Cantilever Hanging Parasol	CRM	£84.99
PARS04	4 x 14kg Parasol Bases (56kg total)	BLK	£79.99



One of our latest bespoke shelter installations at Poole High School, a two-tiered Freestanding Winterbourne Walkway Shelter providing an all-weather outdoor recreation area.

The finished project takes the form of a 12.8m x 11.75m steel tube shelter with guttering, galvanised and powder coated to complement the school colours. This surface treatment means the structure will be guaranteed to last 25 years, serving the school for many years to come.

Can't find what you're looking for? Our expert team can help. From design to installation, styles, configurations and finishes, your shelter can be perfectly tailored to your exact requirements.

**Need a site survey or quote?
Call us on 0800 1777 052**

NBB Outdoors

★ **Trustpilot** ★★★★★
Rated Excellent by our customers

Reasons To Choose NBB Outdoors



Huge Range
We offer hundreds of shelter products to suit any need, location or budget



FREE Delivery
On all orders over £250 (UK Mainland)*



Installation Service
Our shelters can be installed by our team of experts at a time which is convenient for you



Bespoke Shelters
Here at NBB, we can design, manufacture and install bespoke shelters tailored to you



UK Manufactured
With 27 years' experience we manufacture our products in the UK

Comprehensive Range For Every School, Application and Budget



CYCLE STORAGE

Fantastic range of high-quality cycle storage solutions, perfect for any school or educational environment

Pages 23-27



WALKWAY SHELTERS

Walkway and canopy shelters for a cost-effective solution to providing additional sheltered foul weather space for your school

Pages 18-22



CYCLE RACKS & STANDS

Classic Sheffield Cycle Racks and Stands available at market-leading prices

Page 28



RECYCLED PLASTIC FURNITURE

All-weather outdoor furniture made from 100% recycled plastic with market-leading guarantees

Pages 36-47

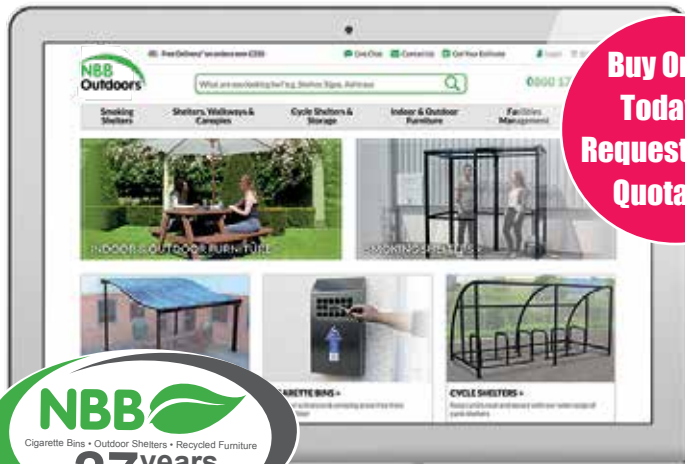

Buy Online Today Or Request A Free Quotation



Call us free on:
0800 1777 052
NoButts.co.uk
Sales@NoButts.co.uk



Return Address: NBB Ltd, Unit 5, Sterte Road Industrial Estate, Sterte Rd, Poole, Dorset, BH15 2AF.

If undelivered to addressee please forward to most suitable person

For fastest service, please quote your catalogue code when ordering

